

Specifying Chart

Windsor					Westminster					Pall Mall					Berkeley					Portland					Knightsbridge																																																																																																																																																																						
<table border="1"> <thead> <tr> <th>Variant</th> <th colspan="4">Dimensions (mm)</th> <th>Wt (kg)</th> </tr> <tr> <th></th> <th>A</th> <th>B</th> <th>C</th> <th>D</th> <th></th> </tr> </thead> <tbody> <tr> <td>Bolevard</td> <td>960</td> <td>520</td> <td>180</td> <td>81</td> <td>12.3</td> </tr> <tr> <td>Street</td> <td>825</td> <td>440</td> <td>160</td> <td>81</td> <td>10.3</td> </tr> <tr> <td>Avenue</td> <td>745</td> <td>390</td> <td>130</td> <td>81</td> <td>8.3</td> </tr> <tr> <td>Court</td> <td>665</td> <td>310</td> <td>125</td> <td>52</td> <td>4.6</td> </tr> <tr> <td>Garden</td> <td>550</td> <td>280</td> <td>125</td> <td>52</td> <td>4.6</td> </tr> <tr> <td>Terrace</td> <td>440</td> <td>240</td> <td>105</td> <td>52</td> <td>2.8</td> </tr> </tbody> </table>					Variant	Dimensions (mm)				Wt (kg)		A	B	C	D		Bolevard	960	520	180	81	12.3	Street	825	440	160	81	10.3	Avenue	745	390	130	81	8.3	Court	665	310	125	52	4.6	Garden	550	280	125	52	4.6	Terrace	440	240	105	52	2.8	<table border="1"> <thead> <tr> <th>Variant</th> <th colspan="4">Dimensions (mm)</th> <th>Wt (kg)</th> </tr> <tr> <th></th> <th>A</th> <th>B</th> <th>C</th> <th>D</th> <th></th> </tr> </thead> <tbody> <tr> <td>Bolevard</td> <td>910</td> <td>460</td> <td>155</td> <td>81</td> <td>11.0</td> </tr> <tr> <td>Street</td> <td>787</td> <td>385</td> <td>135</td> <td>81</td> <td>9.0</td> </tr> <tr> <td>Avenue</td> <td>690</td> <td>340</td> <td>112</td> <td>81</td> <td>5.0</td> </tr> <tr> <td>Garden</td> <td>590</td> <td>300</td> <td>100</td> <td>52</td> <td>3.9</td> </tr> </tbody> </table>					Variant	Dimensions (mm)				Wt (kg)		A	B	C	D		Bolevard	910	460	155	81	11.0	Street	787	385	135	81	9.0	Avenue	690	340	112	81	5.0	Garden	590	300	100	52	3.9	<table border="1"> <thead> <tr> <th>Variant</th> <th colspan="4">Dimensions (mm)</th> <th>Wt (kg)</th> </tr> <tr> <th></th> <th>A</th> <th>B</th> <th>C</th> <th>D</th> <th></th> </tr> </thead> <tbody> <tr> <td>Bolevard</td> <td>910</td> <td>420</td> <td>115</td> <td>81</td> <td>8.8</td> </tr> <tr> <td>Street</td> <td>787</td> <td>360</td> <td>115</td> <td>81</td> <td>7.8</td> </tr> <tr> <td>Avenue</td> <td>660</td> <td>320</td> <td>112</td> <td>81</td> <td>4.4</td> </tr> <tr> <td>Garden</td> <td>550</td> <td>280</td> <td>100</td> <td>52</td> <td>3.0</td> </tr> </tbody> </table>					Variant	Dimensions (mm)				Wt (kg)		A	B	C	D		Bolevard	910	420	115	81	8.8	Street	787	360	115	81	7.8	Avenue	660	320	112	81	4.4	Garden	550	280	100	52	3.0	<table border="1"> <thead> <tr> <th colspan="2">Dimensions (mm)</th> <th>Weight (kg)</th> </tr> <tr> <th>A</th> <th>B</th> <th></th> </tr> </thead> <tbody> <tr> <td>785</td> <td>420</td> <td>7.7</td> </tr> </tbody> </table>					Dimensions (mm)		Weight (kg)	A	B		785	420	7.7	<table border="1"> <thead> <tr> <th colspan="2">Dimensions (mm)</th> <th>Weight (kg)</th> </tr> <tr> <th>A</th> <th>B</th> <th></th> </tr> </thead> <tbody> <tr> <td>765</td> <td>385</td> <td>5.7</td> </tr> </tbody> </table>					Dimensions (mm)		Weight (kg)	A	B		765	385	5.7	<table border="1"> <thead> <tr> <th>Variant</th> <th colspan="4">Dimensions (mm)</th> <th>Weight (kg)</th> </tr> <tr> <th></th> <th>A</th> <th>B</th> <th>C</th> <th>D</th> <th></th> </tr> </thead> <tbody> <tr> <td>Street</td> <td>890</td> <td>610</td> <td>105</td> <td>81</td> <td>9.7</td> </tr> <tr> <td>Avenue</td> <td>761</td> <td>510</td> <td>110</td> <td>81</td> <td>7.8</td> </tr> </tbody> </table>					Variant	Dimensions (mm)				Weight (kg)		A	B	C	D		Street	890	610	105	81	9.7	Avenue	761	510	110	81	7.8
Variant	Dimensions (mm)				Wt (kg)																																																																																																																																																																																										
	A	B	C	D																																																																																																																																																																																											
Bolevard	960	520	180	81	12.3																																																																																																																																																																																										
Street	825	440	160	81	10.3																																																																																																																																																																																										
Avenue	745	390	130	81	8.3																																																																																																																																																																																										
Court	665	310	125	52	4.6																																																																																																																																																																																										
Garden	550	280	125	52	4.6																																																																																																																																																																																										
Terrace	440	240	105	52	2.8																																																																																																																																																																																										
Variant	Dimensions (mm)				Wt (kg)																																																																																																																																																																																										
	A	B	C	D																																																																																																																																																																																											
Bolevard	910	460	155	81	11.0																																																																																																																																																																																										
Street	787	385	135	81	9.0																																																																																																																																																																																										
Avenue	690	340	112	81	5.0																																																																																																																																																																																										
Garden	590	300	100	52	3.9																																																																																																																																																																																										
Variant	Dimensions (mm)				Wt (kg)																																																																																																																																																																																										
	A	B	C	D																																																																																																																																																																																											
Bolevard	910	420	115	81	8.8																																																																																																																																																																																										
Street	787	360	115	81	7.8																																																																																																																																																																																										
Avenue	660	320	112	81	4.4																																																																																																																																																																																										
Garden	550	280	100	52	3.0																																																																																																																																																																																										
Dimensions (mm)		Weight (kg)																																																																																																																																																																																													
A	B																																																																																																																																																																																														
785	420	7.7																																																																																																																																																																																													
Dimensions (mm)		Weight (kg)																																																																																																																																																																																													
A	B																																																																																																																																																																																														
765	385	5.7																																																																																																																																																																																													
Variant	Dimensions (mm)				Weight (kg)																																																																																																																																																																																										
	A	B	C	D																																																																																																																																																																																											
Street	890	610	105	81	9.7																																																																																																																																																																																										
Avenue	761	510	110	81	7.8																																																																																																																																																																																										

The symbol \varnothing indicates external diameter, and id indicates internal diameter.

Lighting Column Kits

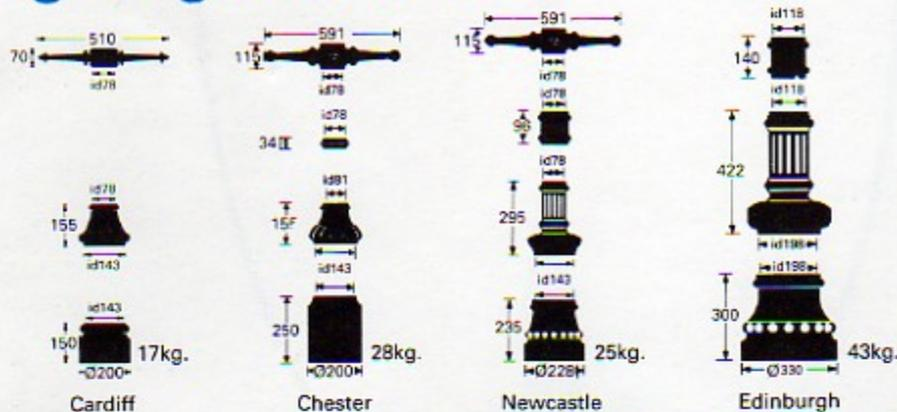

Lamp Posts

Base Details For Lamp Posts and Pedestals

Variant	Dimensions (mm)			Weight (kg)
	A	B	C	
CAMBRIDGE	250	208	16	16
OXFORD	250	210	16	16
NORWICH	250	210	16	16
GLOUCESTER	250	210	16	16
WORCESTER	200	165	16	16
LINCOLN	185	138	10	10
LONDON COL	190	160	10	10
LONDON PED	190	156	8	8
WELLS	140	115	10	10

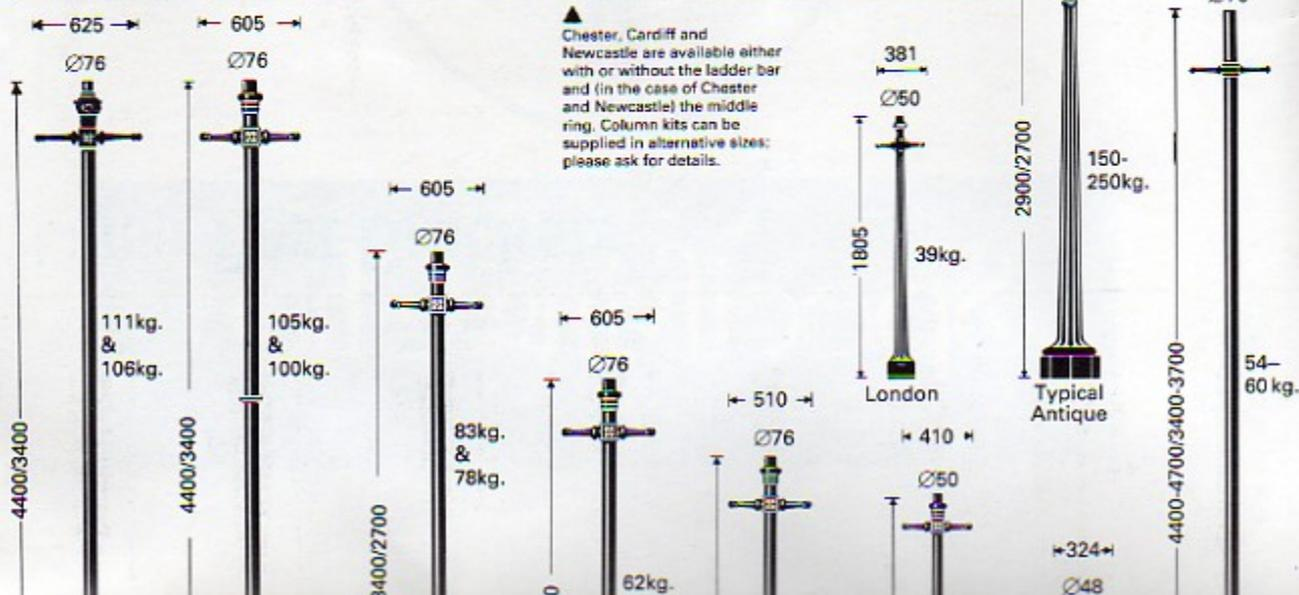

▲ Chester, Cardiff and Newcastle are available either with or without the ladder bar and (in the case of Chester and Newcastle) the middle ring. Column kits can be supplied in alternative sizes; please ask for details.

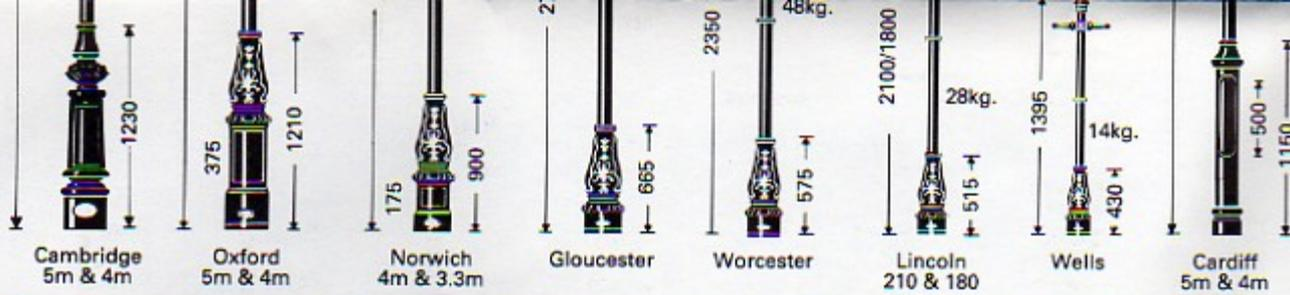

Lamp Post Brackets

OUTREACH ARMS (Also available as double arms)

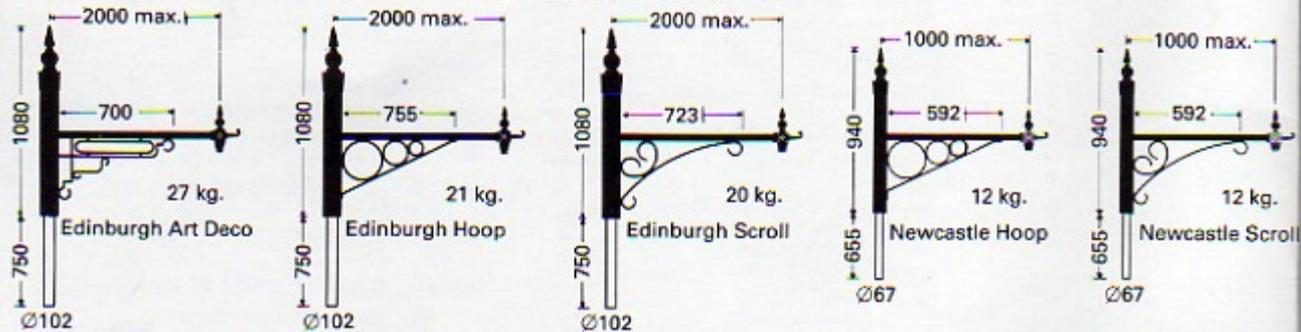

SINGLE/MULTI-ARM BRACKETS

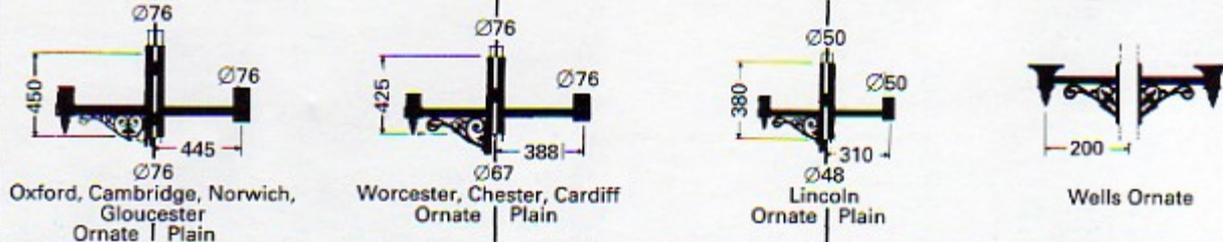

Pedestals

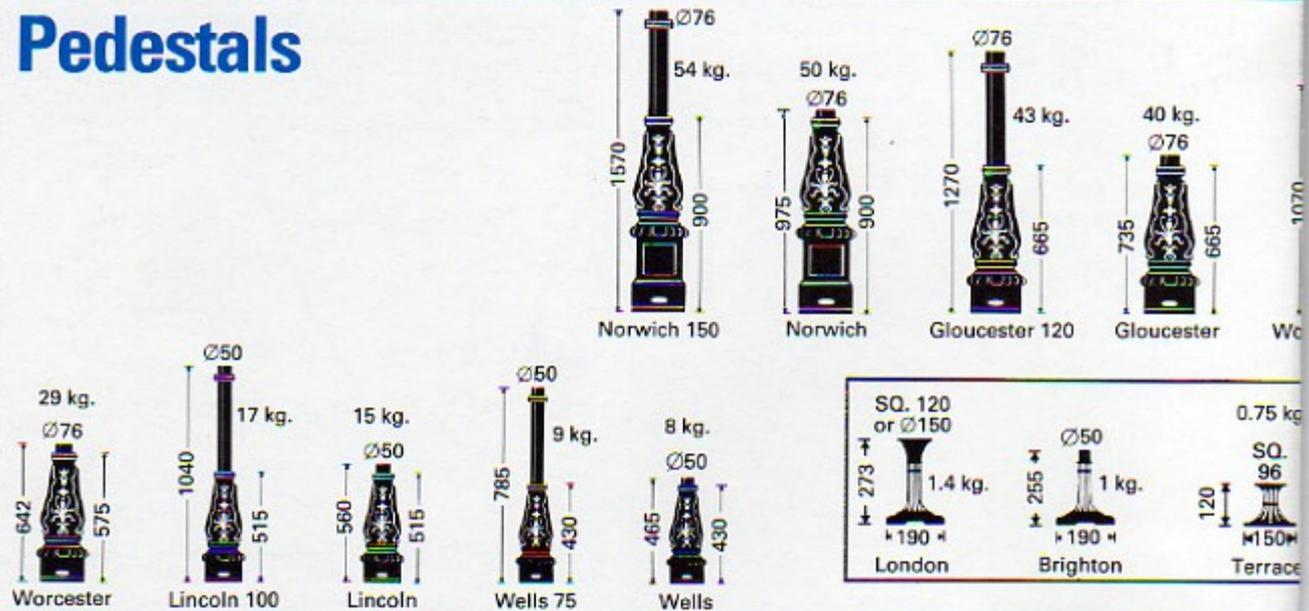

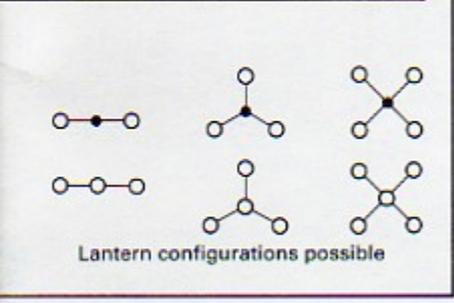
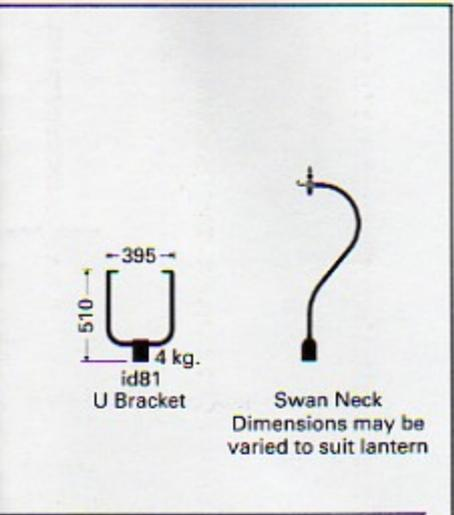
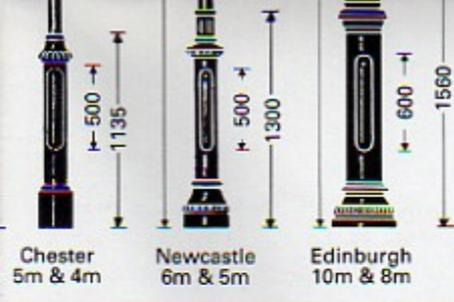

Lamp Bracket															
WELLS ORNATE															
NORWICH	●	●	●				●	●	●		●	●			
NORWICH 150	●	●	●								●	●			
GLOUCESTER	●	●	●				●	●	●		●	●			
GLOUCESTER 120	●	●	●								●	●			
WORCESTER				●								●			
WORCESTER 100				●								●			
LINCOLN					●	●				●		●			
LINCOLN 100					●	●				●		●			
WELLS							●								
WELLS 75							●								
LONDON					●					●		●			
BRIGHTON															
TERRACE							●								
EDINBURGH															
NEWCASTLE															
LARGE	●	●	●				●	●	●		●	●			
SMALL				●	●					●		●			
LARGE PENDANT	●	●	●				●	●	●		●	●			
SMALL PENDANT				●	●					●		●			
FRAME	●	●	●												
PLATE							●								
TERRACE							●								
50W SON	●	●	●				●	●	●		●	●			
70W SON	●	●	●				●	●	●		●	●			
100W SON	●	●	●				●	●	●		●	●			
150W SON	●	●	●				●	●	●		●	●			
250W SON	●	●	●				●	●	●		●	●			
50W SDL MBF/U	●	●	●				●	●	●		●	●			
80W SDL MBF/U	●	●	●				●	●	●		●	●			
125W SDL MBF/U	●	●	●				●	●	●		●	●			
18W SOX															
35W SOX	●	●	●				●	●	●		●	●			
SL18					●	●				●		●			
SL25					●	●				●		●			
MAX. GLS WATTAGE	300	200	200	150	100	60	300	200	200	100	300	200	200	100	
HIGH BEAM REFRACTOR	●	●	●					●	●		●	●			
OPTICAL REFLECTOR	●	●	●					●	●		●	●			
PHOTOCELL	●	●	●					●	●		●	●			
POLYCARBONATE	●	●	●					●	●		STD	STD	●	STD	STD
TOP MOUNT L'HOLDER	STD	STD	STD					STD	STD	STD		STD	STD	STD	●
PENDANT	●	●	●					●	●		●	●			
FRAME	●	●	●					●	●		●	●			
PIR DETECTOR	●	●	●					●	●		●	●			

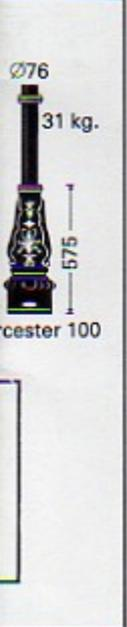

Wall Brackets

Edinburgh Art Deco
27 kg.

Edinburgh Hoop
21 kg.

Large Plain Cast
3.7 kg.

Large Scroll
3.7 kg.

Large Ornate
2.5 kg.

Large Ornate Pendant
2.5 kg.

Terrace
0.8 kg.

Scroll Plate
1 kg.

Corner Adaptors

Corner Adaptor Bracket Dimensions						
BRACKET	A	B	C	D	E	Weight (kg)
SMALL	119	50	38	123	35	0.2
LARGE	231	70	47	214	50	0.4

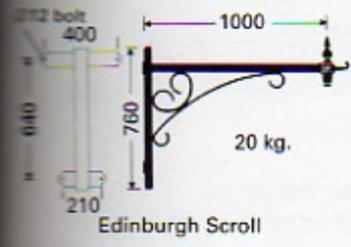
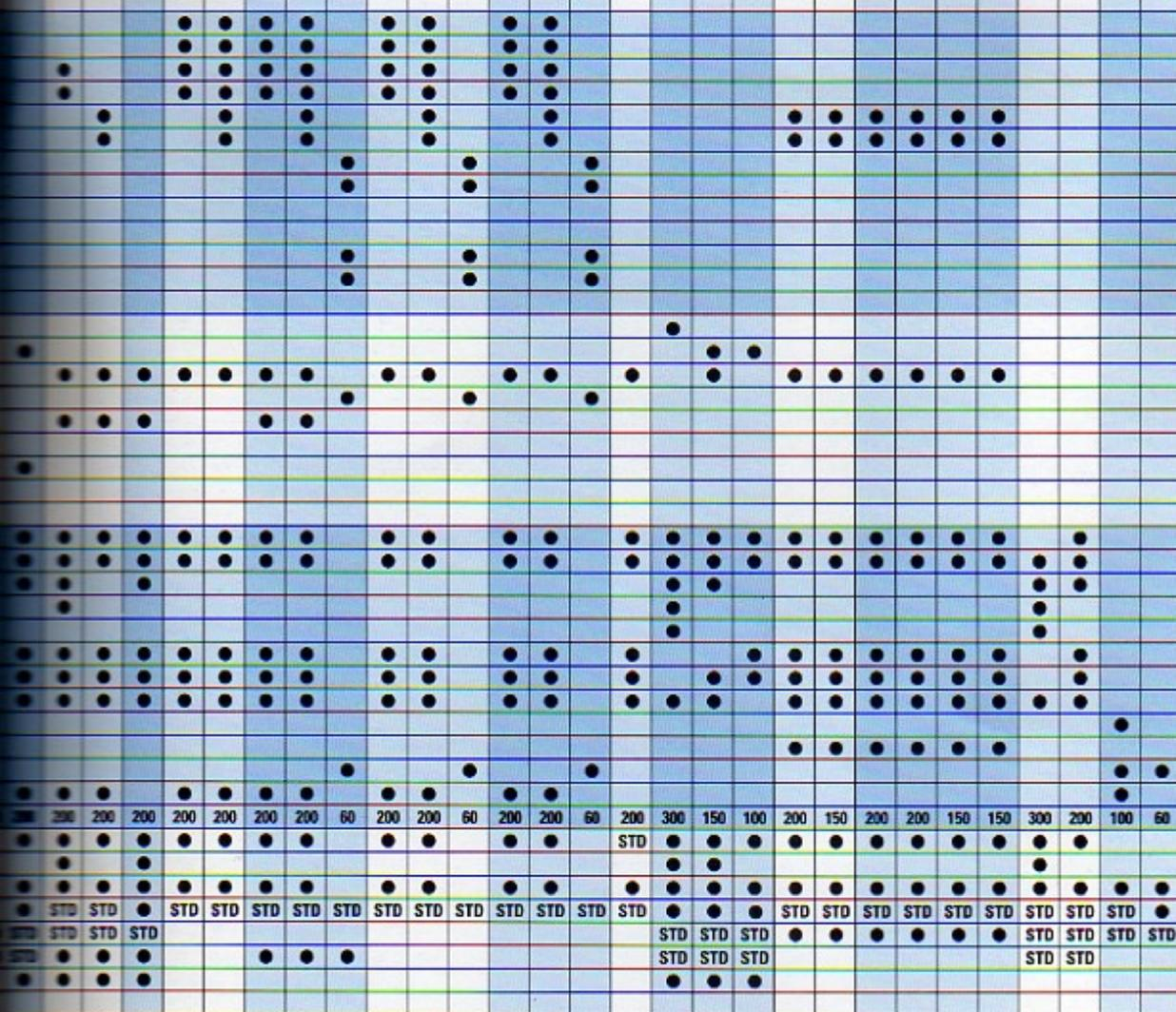

Edinburgh Scroll

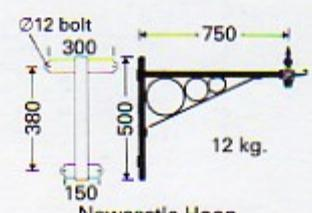

Newcastle Hoop

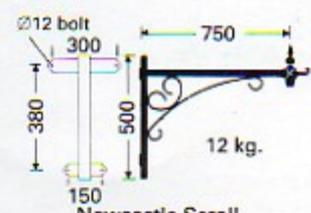

Newcastle Scroll

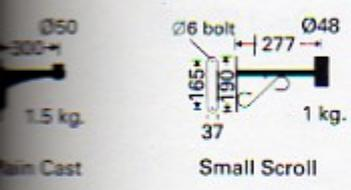

Small Scroll

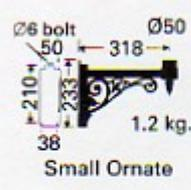

Small Ornate

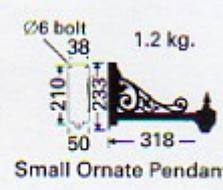

Small Ornate Pendant

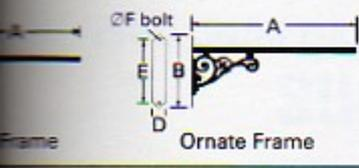

Ornate Frame

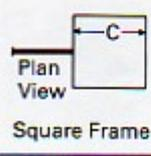

Square Frame

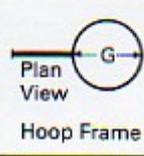

Hoop Frame

Frame Wall Brackets
Dimensions

S=Scroll O=Ornate

	Street		Avenue		Court		Garden	
	S	O	S	O	S	O	S	O
A	836	765	786	715	531	558	499	570
B	445	252	445	252	190	252	190	252
C	394	394	344	344	279	279	247	247
D	70	50	70	50	37	50	37	50
E	400	222	400	222	165	222	165	222
F	8	8	8	8	6	8	6	8
G	398	398	330	330	-	-	288	288
KG	4.9	5.1	4.5	5.0	1.5	2.2	1.4	2.1

Features and Options

Based on a Windsor Street lantern and Oxford lamp post.

STANDARD FEATURES

OPTIONS

FINIAL AND DOME – securely fixed with 8mm \varnothing bolt

Finial can be replaced by a fabricated cast crown

LOWER BELL – secured to hood with 4 brass nuts and bolts

3 standard finishes; any BS or RAL colour on request

HOOD – rigid construction with strong flush seam

Photo electric cell (p.e.c.) for automatic switching

DECORATIVE LEAVES – soldered to both side and bottom faces of lantern frame for extra rigidity

Hinged lid for access to integral control gear

BADGE – individually numbered, giving a record of the lantern's creator

Choice of advanced optical reflectors and refractors

FIXING BOLTS – stainless steel, fastened through lantern base

Glazing in acrylic or polycarbonate; other materials on request. Many colours and textures available

FROG – tough polyester powder-coated and stoved

Access door can be sealed with neoprene

CONDUIT – within frog to protect supply to lantern

Anti-theft security fixings to "lock" lantern to frog

LADDER ARMS – cast iron, secured through lamp post shaft

Fused terminal block in lantern base

STEEL SHAFT – internally coated with bitumen. Shot blasted, sprayed with aluminium and coated with red oxide externally

Passive infra-red (p.i.r.) detector for security lighting

Height of steel-shafted lamp posts can be varied

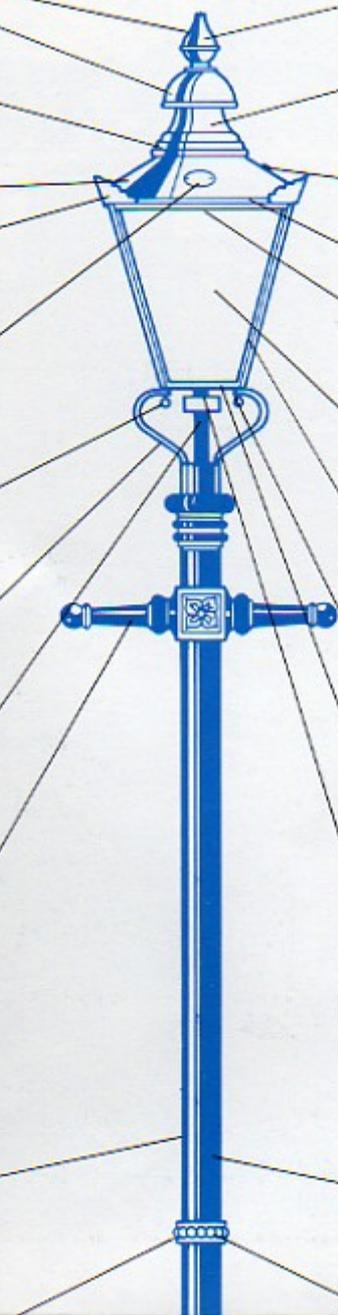

Shaft ring is optional on 4m lamp post
feature on 5m lamp post

Shaft ring is optional on 4m lamp post

JOINT – shaft is mechanically fixed and welded into base; joint covered with elastic sealant for added protection against corrosion

BASE – high quality iron casting

BASE COMPARTMENTS – large access door with vandal-resistant screw and preservative-treated wooden backboard

Crest or logo can be cast on to access door

Choice of fabricated root (illustrated) or anchor bolts. Fabricated roots are coated both internally and externally with bitumen, and supplied with 16mm \varnothing bolts to fix to lamp post

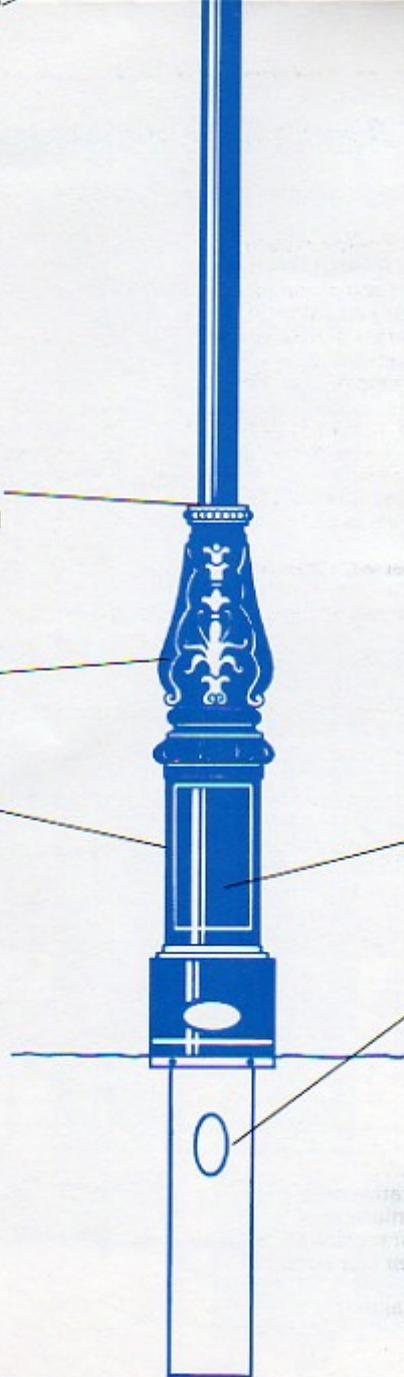

Materials specification

Lanterns

Windsor, Westminster, Pall Mall, Berkeley, Portland, Knightsbridge, Lancaster, Burlington.

Copper with brass fittings and stainless steel fixing bolts. Lead coronets on Berkeley and Westminster, Boulevard and Street. Gunmetal coronets on Westminster, Avenue and Garden. Finish: natural, black stove enamel or polished and lacquered. Glazing: clear acrylic or polycarbonate.

Paddington and Pimlico

Copper with brass fittings and stainless steel fixings. Finish: natural, black stove enamel or polished and lacquered. Glazing: Pimlico clear frosted or crystal amber acrylic. Paddington clear polycarbonate.

Strand

Spun aluminium with stainless steel fixings. Finish: polyester powder coated black as standard, reflector plate white. Bowl: clear acrylic or polycarbonate.

Globes

Frosted polycarbonate. Globes with Highbeam option supplied in frosted or clear polycarbonate. Base in cast aluminium, alternative base fitted on 400mm globes when integral gear is required and is available for 500mm globes as an option. Decorative metalwork in aluminium. Finish: metalwork polyester powder coated black.

York, Warwick

Spun aluminium hood and cast aluminium base with stainless steel fixings. Decorative coronet on Warwick in cast aluminium. Finish: polyester powder coated black. Glazing: internally reeded clear polycarbonate. **NB:** Polished and lacquered finish not recommended for lanterns installed in exposed coastal areas.

Lamp Posts

Cambridge, Oxford, Norwich

Mild steel shaft, aluminium metal sprayed externally, bitumen coated internally, cast iron base with lockable door to compartment having wooden backboard; earth

Gloucester, Worcester

bolt fitted. Cast iron ladder bar assembly. Finish: red oxide primer.

Lincoln, Wells

Mild steel shaft, aluminium metal sprayed externally, bitumen coated internally. Finish: red oxide primer.

London

Mild steel shaft and cast iron base and top sections. Finish: red oxide primer.

Edinburgh

Cast iron
Finish: red oxide primer.

Tubular steel with cast iron decoration. Finish: aluminium metal spray on tubular steel with black protective material on root section. Castings painted with red oxide primer.

Cardiff, Chester, Newcastle

Tubular steel with cast iron decoration. Finish: red oxide primer over cast iron and aluminium metal sprayed tubular steel. Root covered in black protective material.

Renovated Antique Cast Lamp Posts

Cast iron
Finish: shot blasted and red oxide primer.

Brackets

Edinburgh, Newcastle, Chester

Mild steel
Finish: red oxide primer.

Plain Multi Arm

Mild steel
Finish: red oxide primer.

Ornate Multi Arm

Mild steel and malleable iron.
Finish: red oxide primer.

Cast, Ornate, Terrace

Cast aluminium
Finish: polyester powder coated black.

Scroll, wall brackets and frogs

Mild steel
Finish: polyester powder coated black.

Pedestals

London, Brighton, Terrace

Cast aluminium
Finish: polyester powder coated black.

Norwich, Gloucester, Worcester, Lincoln, Wells

Cast iron base with mild steel extension where applicable. Finish: red oxide primer.

Installation recommendations

Electrical Components for Lanterns

Lanterns

In accordance with BS 4782, where appropriate. For use on 240V 50Hz supply.

On receipt, carefully unpack and inspect thoroughly – report any damage immediately. Some lanterns are packed with hoods inverted and lampholders loose to reduce handling risks. Installation should be carried out by a qualified electrician ensuring that the maximum permitted lamp wattage is not exceeded.

Pedestals and Wall Brackets

These are not supplied with fixing bolts as the type required will depend on the construction and condition of the wall or coping. Fixing methods should always allow for the worst possible conditions.

Tubular Steel Lamp-posts: Edinburgh, Newcastle, Chester and Cardiff

Mounting Height (m)	Root Length (mm)
4 & 5	800
6	1000
8	1200
10	1500

Tubular steel lamp posts have integral roots finished internally and externally in bitumen.

Cast Iron Lamp-posts

Antique lamp-posts have integral roots. Other cast iron lamp-posts can be installed with anchor bolts or fabricated roots, each available at extra cost. Fabricated roots are finished internally and externally in bitumen.

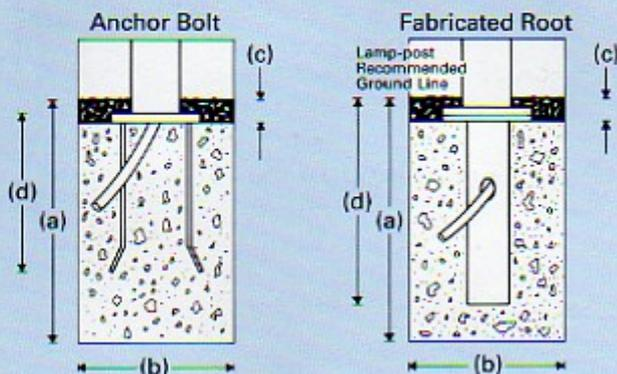

Recommended bases for installation of lamp-post



Good quality well compacted concrete.

Dimensions Assume Normal Ground Conditions

		(a)	(b)	(c)	(d)
Norwich	Anchor Bolts	750	600	60	400
Gloucester	Anchor Bolts	750	550	40	410
Lincoln	Anchor Bolts	450	350	40	255
Wells	Anchor Bolts	450	350	40	255

These installation recommendations are offered for guidance only and imply no responsibility.

DW Windsor Limited has the policy of continuous product improvement and development and reserves the right to amend specifications without prior notice.

The illustrations and copy in this specifying chart cannot be reproduced without permission.

© DW Windsor Limited, May, 1990.