



SANGAMO

round
PATTERN



Please Note:

Sangamo Limited acquired Actaris UK Ltd, Port Glasgow on the 2 December 2002.

All references and addresses should be replaced by Sangamo Limited.



Introduction

The **SANGAMO** Round Pattern Time Switches have been manufactured at Port Glasgow on the Clyde Estuary for over 50 years. In November 2001, the Port Glasgow facility was acquired by Actaris as part of the acquisition of all the Resource Management Services (RMS) Division of Schlumberger throughout the world. Actaris are a worldwide Meter Manufacturer.

More than 6 million **SANGAMO** Round Pattern Time Switches have been installed, with quality and reliability being the hallmark for Port Glasgow. However, at Port Glasgow, quality is much more than a product attribute - it is a fundamental approach to everything which the company undertakes.

For further information on any of our products, call our Sales Office on (01475) 747 574.

Alternatively you can write to:

Actaris UK Ltd,
Industrial Estate,
Port Glasgow,
Renfrewshire,
PA14 5XG.



round
PATTERN

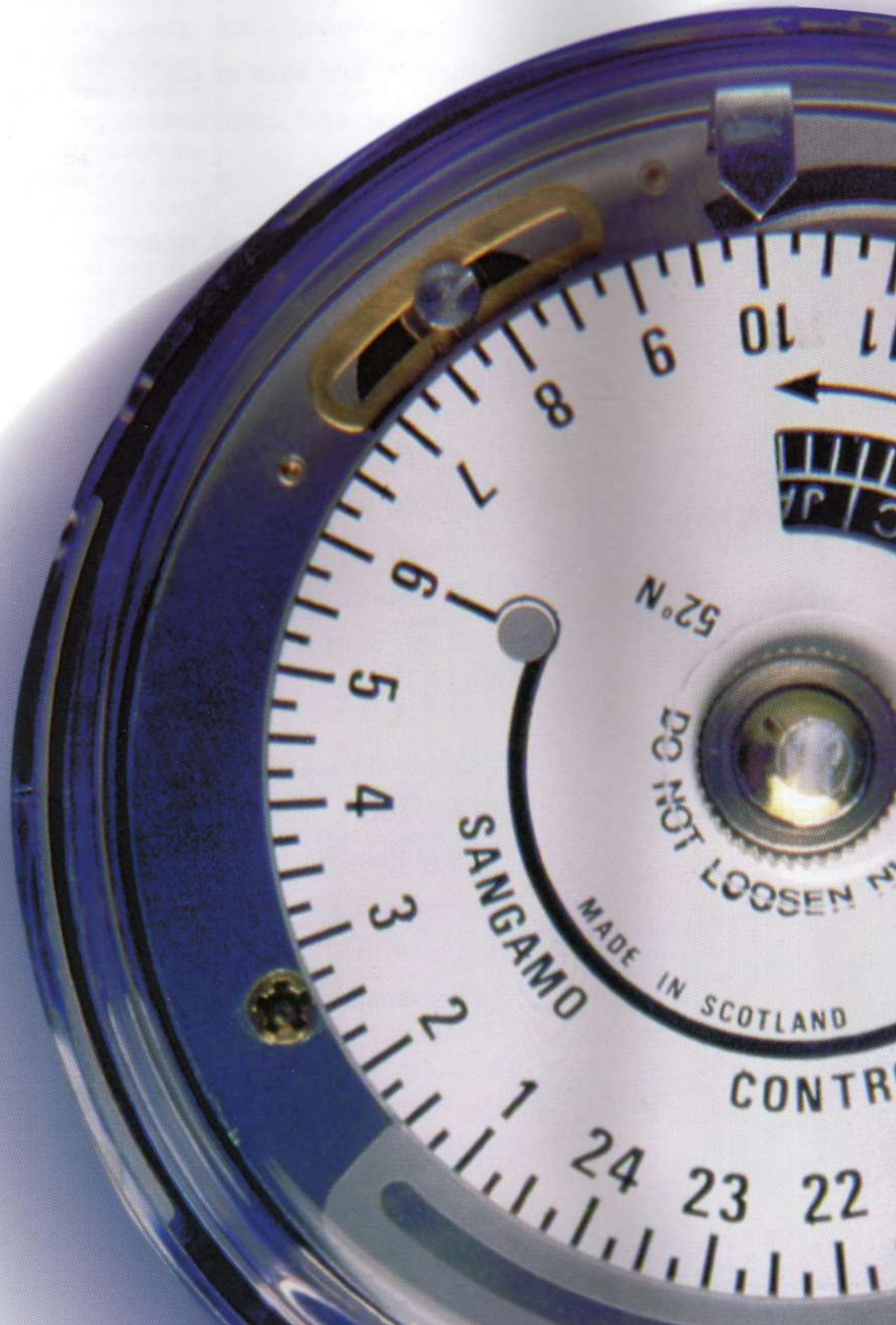

round pattern time switches

Round Pattern Time Switches are renowned for their simplicity and ease of use in industrial and commercial installations.

They consist of 2 basic types: Standard and Solar models.

Round Pattern products are unique in that all models have a 20 amp switching capability, allowing the products to be utilised in many heavy duty applications where the use of contactors cannot be warranted.

To cater for a wide variety of applications, the range of Round Pattern Time Switches includes 3 distinct groups, each with its own unique characteristics.

S250 Series



24 hour quartz controlled **without** battery reserve
Solar dial versions available.
(See page 6)

Q550 Series



24 hour quartz controlled **with** battery reserve.
Solar dial versions available.
(See Page 6)

E850 Series



Flexible, 7 day, fully programmable electronic control with battery reserve. Allows up to 48 ON and 48 OFF operations per day.



round
PATTERN

reliable

Sangamo Round Pattern Time Switches are supremely reliable; proven in millions of installations, they are true fit-and-forget switches which will provide many years of maintenance free operation. The switches are built to the highest standards - both the S250 and Q550 are guaranteed for 5 years (applies to UK and Southern Ireland only), and the E850 guaranteed for 3 years. Most models have BEAB approval and the company operates to a quality system approved by BSI against BS EN ISO 9001.

versatility

The choice of basic models with a wide selection of configuration options and generous 20 amp switching capability, means that Round Pattern Switches are available to suit most general purpose a.c. applications. The 24 hour models are ideal for simple fixed daily switching cycles, with a choice of battery maintained quartz control where it is important to guarantee continuity of timing. Solar dial versions provide automatic compensation for sunrise/sunset time variation. For more complex switching operations, the sophisticated electronic models provide full programmability up to 7 days.

Whichever Round Pattern model suits your application, it will provide the same convenience, reliability and value for money so familiar to Sangamo customers.

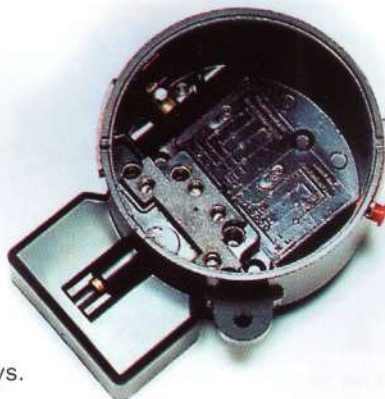

24 hour switches

All have a 24 hour programming cycle and perform the same sequence of switching operations on each day.

Both series offer similar facilities, but the Q550 models include a reserve battery which will maintain timing operation for up to 100 hours in the event of a mains power failure. This feature is particularly useful where large numbers of switches are involved, eliminating the considerable trouble and expense of resetting after a power cut.

All 24 hour switches can be quickly and easily programmed using small manual levers on their dials. Depending on the model chosen, up to 3 ON and 3 OFF (or 6 changeover) operations per day are possible and the switches will normally perform the same sequence every day. However the unique "day omission" device can select any number of days in the week on which the switching cycle will be disabled. Several of the Q550 models also allow a selected operation in the programmed cycle to be brought forward on one day in the week.

day omission

Most models omit ON operations on the selected days, but models omitting OFF operations are available.

early operation - 24 hour models only

Available only on some Q550 models. The day for early switching is determined by the positioning of an "early" lever. This is particularly suitable for early ON/OFF operations within retail premises.

7 day

The E850 series is a range of 7 day switches allowing the added flexibility of up to 48 ON and 48 OFF (or 96 changeover) operations per day. Automatically allows for changes between British Summer Time and Greenwich Mean Time.

round pattern solar models

Solar Time Switches are ideal for any application which requires control linked to sunset and sunrise times.

Popular applications for solar time switches include street, stairwell and security lighting.



S250 Solar



Q550 Solar



cost savings

Once set, the switches track sunset and sunrise throughout the year, *without the need to sense light levels*. This avoids the installation and maintenance problems associated with photosensing models and means they can be left to operate unattended for years.

S250 and Q550

solar models

Two standard versions of each solar dial switch are available, with different operating options. The simpler version, known as Form 13, gives one ON and one OFF operation per day. The ON operation always tracks sunset while the OFF operation can be made either to track sunrise, or to occur at a fixed time between 8.30pm and 1.00am.

Form 14 has one ON and one OFF operation which track sunset and sunrise times respectively and has the added facility of allowing you to select a fixed OFF period between 8.30pm and 1.00am, and a fixed ON period between 3.15 am and 8.30 am.

Because the times of sunrise and sunset vary with latitude, four standard dials are available for use in the UK each corresponding to a geographical zone. (See diagram below).

Other dials are available on request for applications outside the British Isles. Adjustments may be made to accommodate longitudinal variations.

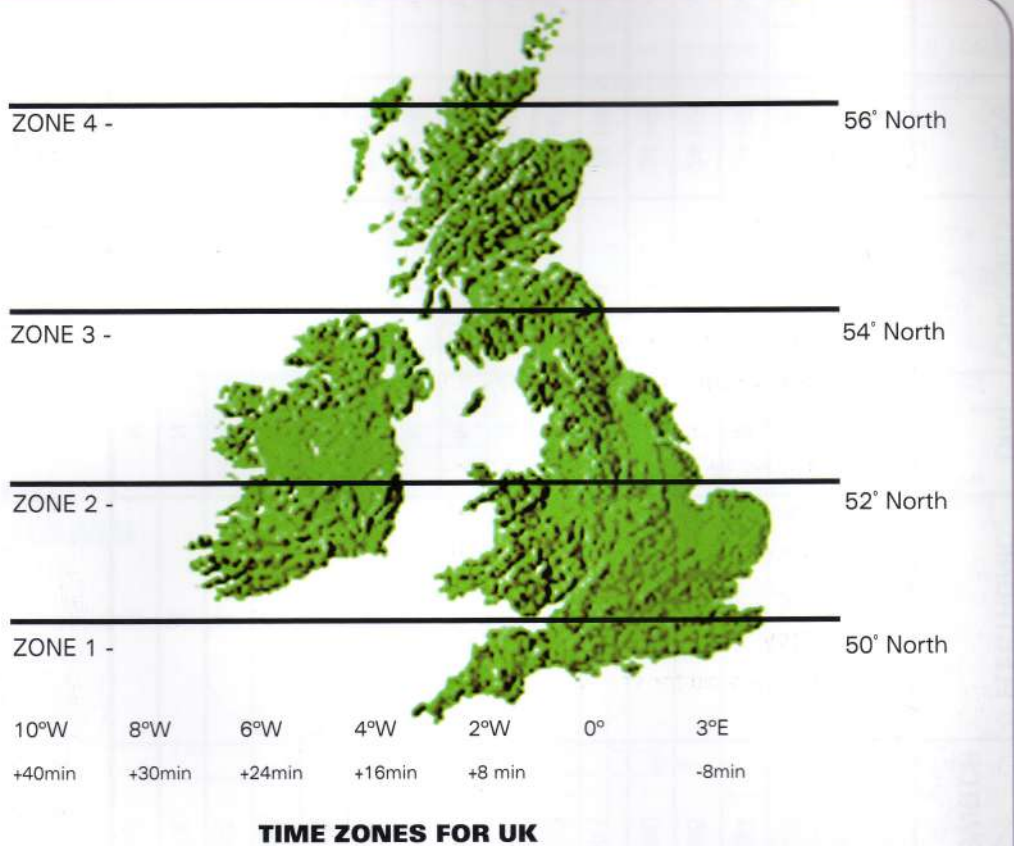

Quick Reference Chart for Round Pattern Time Switches

FUNCTION/ SWITCH	QUARTZ/ ELECTRONIC	SOLAR DIAL	NO. OF CHANNELS	TIMER PROG.	BATTERY RESERVE	OMIT DEVICE	EARLY OPERATIONS (SOLAR MODELS F13)	EARLY 'DEVICE' (STANDARD MODELS)	SWITCH TYPE	BASE PINS	MAX OPERATIONS PER 24 HOURS
S251	Q	Y	1	24 HR	N		OFF		SPST	3	2 or 4
S253	Q	Y	1	24 HR	N		OFF		SPST	4	2 or 4
S254	Q	N	1	24 HR	N	ON			SPST	3	6
S255	Q	N	1	24 HR	N	ON			SPST	4	6
Q550	Q	Y	1	24 HR	Y	ON	OFF		SPST	3	2
Q551	Q	Y	1	24 HR	Y		OFF		SPST	3	2 or 4
Q553	Q	Y	1	24 HR	Y		OFF		SPST	4	2 or 4
Q554	Q	N	1	24 HR	Y	ON			SPST	3	6
Q555	Q	N	1	24 HR	Y	ON			SPST	4	6
Q557	Q	N	1	24 HR	Y	OFF			SPST	4	6
Q559	Q	N	1	24 HR	Y	ON		OFF	SPST	4	6
Q563	Q	N	1	24 HR	Y	ON			SPDT	4	6
Q586	Q	N	1	24 HR	Y	ON		ON	SPST	4	6
E854	E	N	1	7 DAY	Y				SPST	3	96
E855	E	N	1	7 DAY	Y				SPST	4	96
E863	E	N	1	7 DAY	Y				SPDT	4	96

round pattern time switches



round
PATTERN

Specifications S250 and Q550 Models

PROGRAMMING	24 hour programme with up to 3 ON and 3 OFF (6 changeover) operations per day
DISPLAY	24 hour dial or solar dial
MOUNTING	Surface mounting
CURRENT RATING	SPST: 20A resistive, SPDT: 20A resistive for circuit A and 10A resistive for circuit B
SUPPLY	230V, 50/60Hz a.c.
RESERVE (Q550)	100 hrs (providing battery has been charged for 300 hrs)
TEMP OVERRIDE FACILITY	Advance to 'off', when program 'on' and will remain 'off' until next 'on' operation and vice versa.
CABLE SIZE	6.0mm ²
TIMING ACCURACY	5 mins/year
POWER CONSUMPTION	0.6W at 230V
AMBIENT TEMPERATURE RANGE	Designed to operate over a temperature range of 0°C to 50°C continuous.
LIVE PARTS PROTECTION	This timer is totally protected by its enclosure
DIRT PROTECTION	Normal domestic dust deposits only
MOISTURE PROTECTION	Ordinary: has no special protection against moisture
SHOCK PROTECTION	Class 1 (Product must be earthed)
DIAL CALIBRATION	15 min divisions
SETTING ACCURACY	+/-3 minutes
PERIOD BETWEEN UNLIKE OPERATIONS	15 minutes minimum
PERIOD BETWEEN LIKE OPERATIONS	1 3/4 hours minimum
PERIOD BETWEEN EARLY OPERATION AND PRECEDING NORMAL OPERATION	3 hours minimum
PERIOD BETWEEN EARLY OPERATION AND SUBSEQUENT NORMAL OPERATION	1 3/4 hours minimum
BEAB APPROVAL	Most models comply
DIMENSIONS	Height (wall mounted) 136mm, width 105.7mm, projection 82mm (Total height 146.5mm)

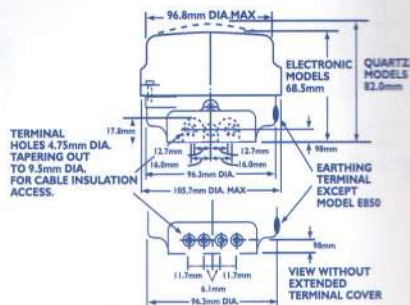
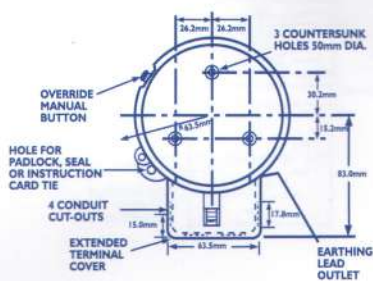

WIRING DIAGRAMS

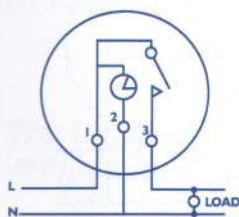

3 Pin models:

S251 Q550
S254 Q551
Q554

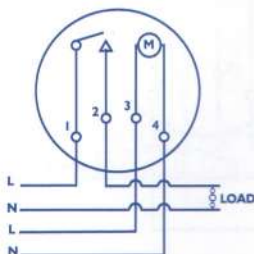

4 Pin models:

S253 Q555
S255 Q559
Q553 Q586
Q557

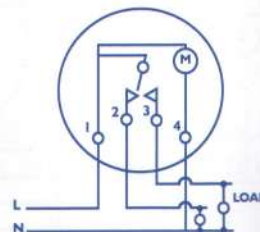

Changeover models:

Q563

round pattern time switches



round
PATTERN

Specifications E850 Models

PROGRAMMING	7 day programme with up to 48 ON and 48 OFF (96 changeover) operations per day
DISPLAY	Digital display showing real time, day, date, month and year where applicable. Simulated analogue display showing real time and programme for current 24 hours
MOUNTING	Surface mounting
CURRENT RATING	20A resistive for SPST and SPDT
SUPPLY	230V, 50/60Hz a.c.
RESERVE	Automatically rechargeable battery will retain memory for typically 50 days.
TEMP OVERRIDE	2 hour boost - when programme "OFF". Advance to "OFF" when programme "ON" and will remain "OFF" until next "ON" operation.
CABLE SIZE	6.0mm ²
TIMING ACCURACY	Better than 5 minutes per annum
HOLIDAY MODE	Suspends programs for 14 days
BST/GMT CHANGEOVER	Automatic
AMBIENT TEMPERATURE RANGE	Designed to operate over a temperature range of 0°C to 35°C continuous
LIVE PARTS PROTECTION	This timer is totally protected by its enclosure
DIRT PROTECTION	Normal domestic dust deposits only
MOISTURE PROTECTION	Ordinary: has no special protection against moisture
SHOCK PROTECTION	Class II (Both functional and supplementary insulation)
PERIOD BETWEEN ON/OFF OPERATIONS	15 mins
DIMENSIONS	Height (wall mounted) 136mm, width 105.7mm, projection 68.5mm (<i>Total height 146.5mm</i>)
BEAB APPROVAL	Most models comply

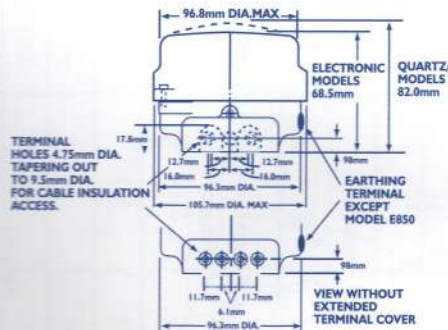
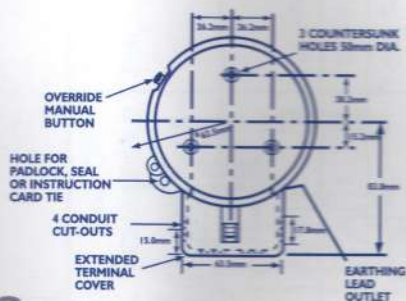

WIRING DIAGRAMS

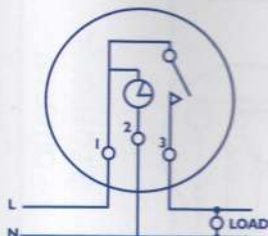

3 Pin models:
E854

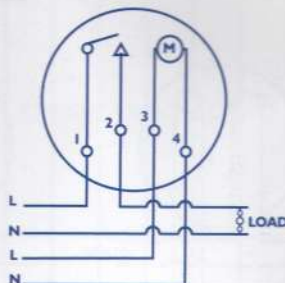

4 Pin models:
E855

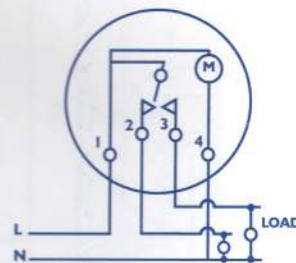

Changeover models:
E863

Conduit Entry Boxes

Dimension diagrams

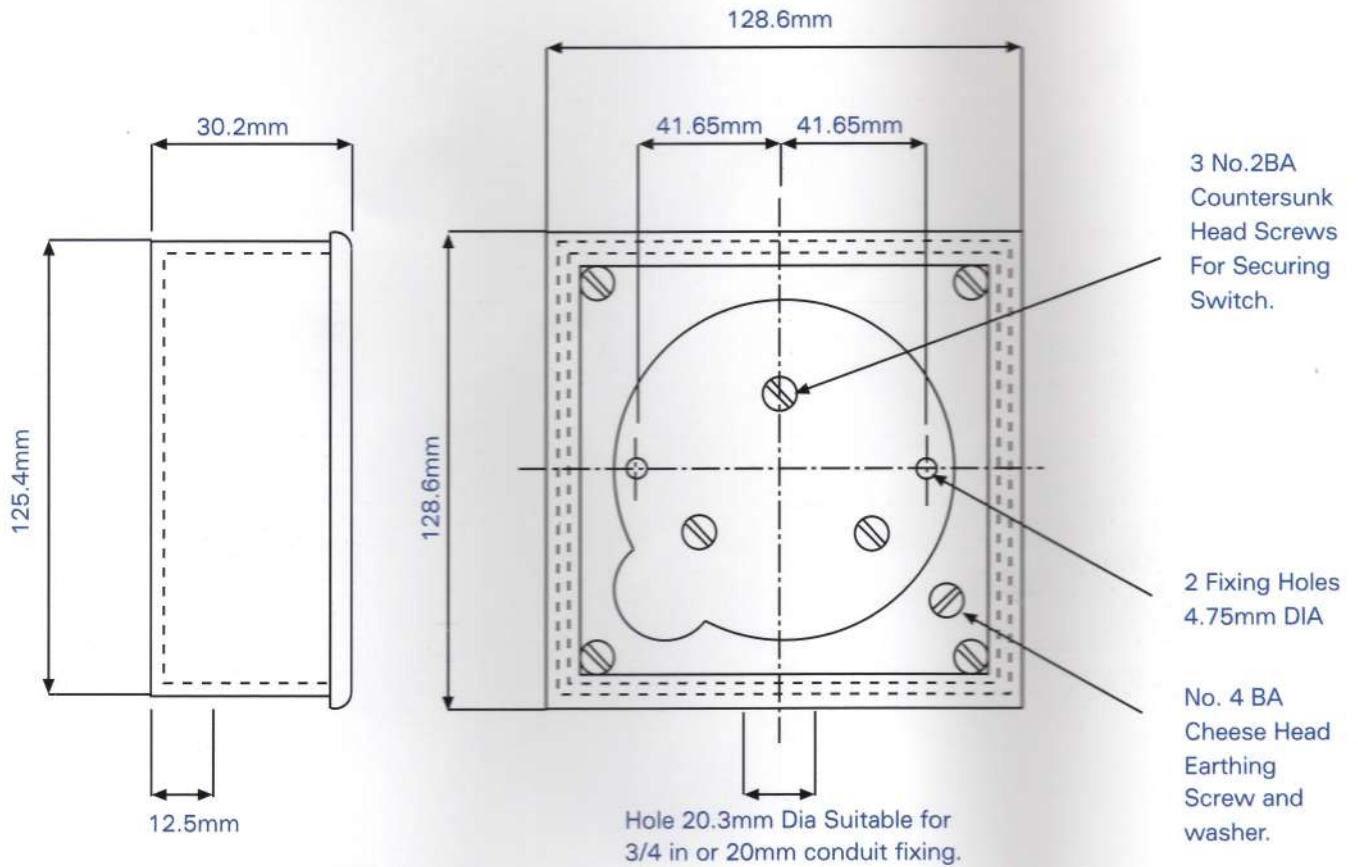

FD930: For the Round Pattern Range of Sangamo Time Switches

The Conduit entry boxes are designed for interior use, FD930 is made of pressed steel with a black stove enamel finish

CUSTOMER CARE POLICY

As part of Actaris's continuous improvement programme, the Company operates a Customer Care Policy. This means that we welcome your comments and complaints, as it can only help us to improve our services to you, our customer.

Due to our policy of continuous product improvement and development, the specifications in this guide may be subject to change without prior notice.

Actaris UK Ltd
Industrial Estate, Port Glasgow
Renfrewshire, PA14 5XG
Tel: +44 (0)1475 747 574
Fax: +44 (0) 1475 744 567
Web: www.sangamo.co.uk