

Domestic Lighting Fittings

Introduction

A range of decorative fittings, primarily intended for use in the home, but equally suitable for many commercial interiors. Glass, plastic and metal are used to produce a versatile collection to provide sparkle and gaiety. A range of conventional and circular fluorescent fittings is also included.

Index

- 4:2 Junior Starr range
- 4:3 Junior Modern range
- 4:4 Droplette
- 4:5 Dolly
- 4:6 4:7 Modern adjustable pendants
- 4:8 Show-off range
- 4:9 4:10 Modern domestic spotlights
- 4:11 Pin-up
- 4:12 Pan floor stands
- 4:13 Ceramic based lamp and Yo-Yo
- 4:14 Modern domestic cylinders and Novelle
- 4:15 Au Pair and One-up
- 4:16 Viewpoint
- 4:17 Netaline
- 4:18-4:20 Circline

Junior Star range

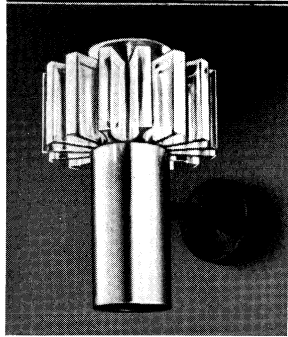

WJB 1040



WJP 3040

WJP 1040

This range has been designed to create a sparkle in home lighting – at little cost to the customer. Junior Star produces its unique sparkle effect through a diffuser in the form of an externally ribbed tube made in clear acrylic. The light from a 40W candle lamp is transmitted by the diffuser over its fifteen ribs. Result: an edge-lit or sparkle effect that makes lighting a part of home decoration.

There are three different fittings in the Junior Star range, all inexpensively priced: single or triple way suspensions (WJP) and a wall bracket (WJB). The suspension fittings include black ceiling plates, flex and sateened and lacquered tubes. The wall bracket fittings are finished in matching shades. All three fittings come complete with a 40W candle lamp.

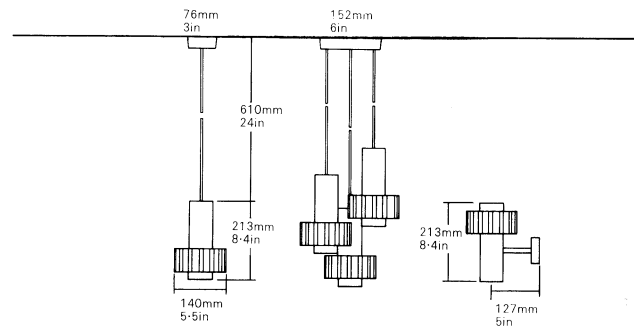

	Catalogue no.	Weight	
		kg	lb
Single suspension	WJP 1040	0.58	1.25
Triple suspension	WJP 3040	1.58	3.5
Wall bracket	WJB 1040	0.58	1.25
Spare diffuser	WJD 1040	0.22	0.5

Junior Modern range

The Junior Modern range offers a low priced means of enjoying the charm of crystal style glass and giving your decor that extra touch of luxury. Colours available include amber and clear in a crystal pattern and opal, orange and green flashed opal in the simple alternative style. These fittings can be used singly or in clusters over a dining table or high on the ceiling in hallways, etc. A matching wall bracket is included in the range. Suspended on a black cable, the lampholder is shrouded in a chromium plated shield. Glass packed complete with 60W lamp.

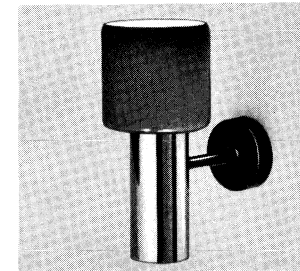

WXB 1 with WXGG

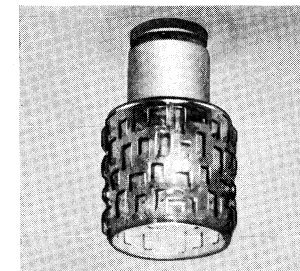

WXP 1 with WXGA

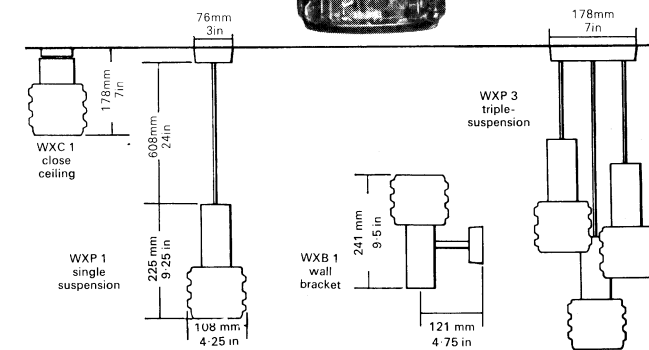

Glasses and Suspensions to be ordered separately

Glasses				Suspensions			
Catalogue no.	Colour	Weight (ex. lamp)		Catalogue no.		Weight	
		kg	lb			kg	lb
WXGA	Amber	0.4	0.875	WXP 1	Single	0.45	1
WXGC	Clear	0.4	0.875	WXP 3	Triple	1.2	2.5
WXGG	Green flashed opal	0.4	0.875	WXB 1	Wall bracket	0.45	1
WXGO	White opal satin etched	0.4	0.875	WXC 1	Close ceiling	0.22	0.5
WXGR	Orange flashed opal	0.4	0.875				
WXYO	Ribbed white satin opal	0.44	0.937				
WXYR	Ribbed orange opal	0.44	0.937				
WXZO	Plain white satin opal	0.44	0.937				
WXZR	Plain orange opal	0.44	0.937				

Droplette pendants

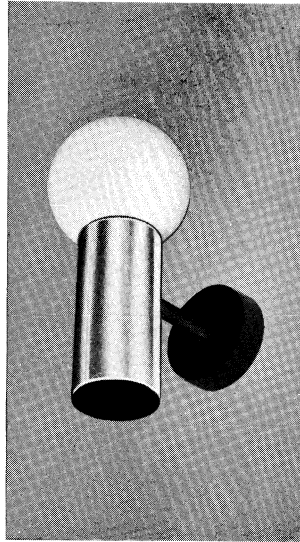

WDB 1CP

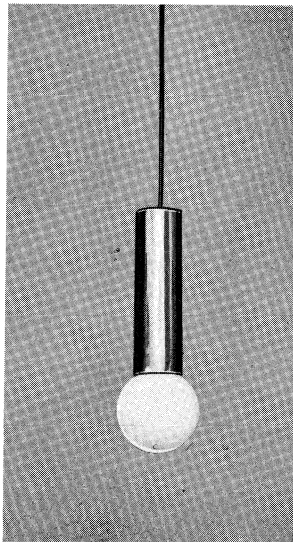

WDP 1CP

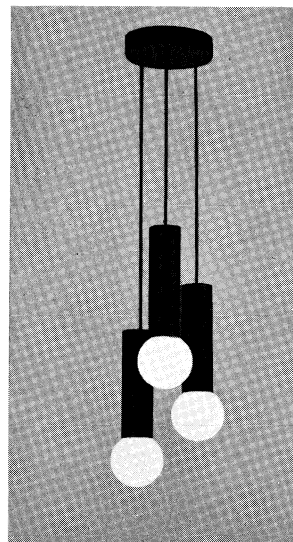

WDP 3B

Droplette pendants

A comprehensive range of pendants with matching wall bracket for use with 60W and 40W Decor, 100mm round lamps.

Suspended on black cable from black ceiling plate fitted with cylindrical trim to lampholder in chromium plated finish or alternatively matt black. Available in a single, three and five way pendants with matching wall bracket.

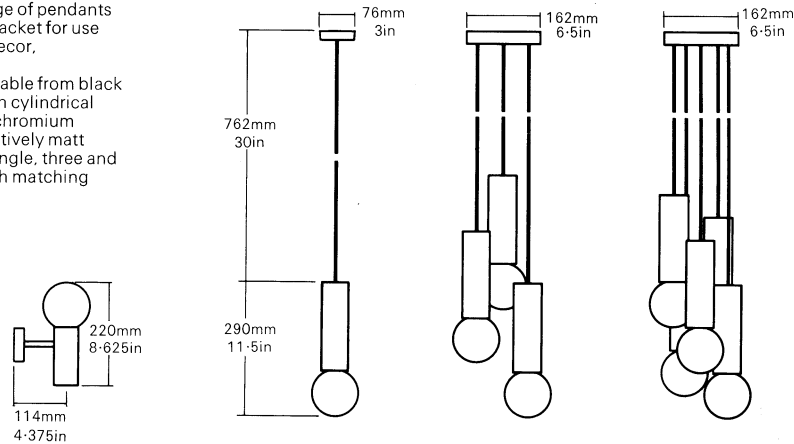

Range

Catalogue no.	Description
WDP 1CP	Single pendant with chromium tube
WDP 1B	Single pendant with black tube
WDP 3CP	Triple pendant with chromium tube
WDP 3B	Triple pendant with black tube
WDP 5CP	Five way pendant with chromium tube
WDP 5B	Five way pendant with black tube
WDB 1CP	Single wall bracket with chromium tube
WDB 1B	Single wall bracket with black tube

Dolly light

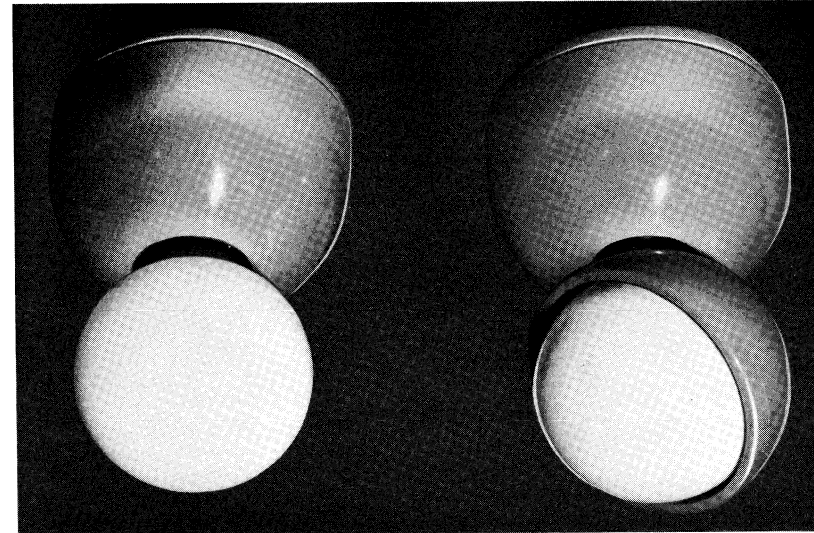

DRB 40R

DRB 40R and DRC 40R

Dolly light

A versatile plastic moulded base for use with the 40W Decor 100mm round lamp.

Moulded in polycarbonate and practically unbreakable. Available in two colours—red or white. A matching cowl partly to shroud lamp is available as an optional extra and is being included in complete pack. Suitable for wall or ceiling mounting as well as a table lamp. Wired switched lead also included in complete pack. Packed in decorative carton.

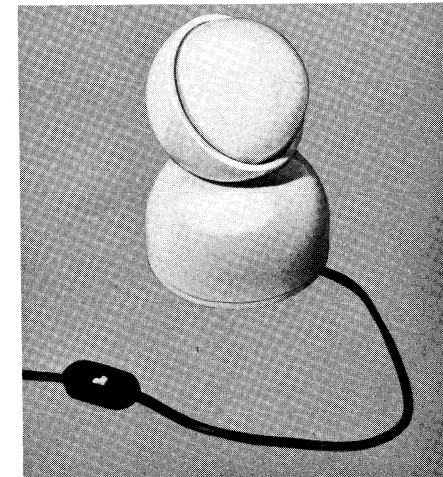
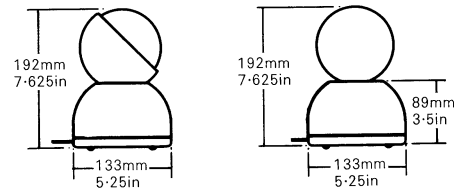

DRP 40W

Range

Catalogue no.	Description	Weight	
		kg	lb
DRP 40R	Basic pack comprising red moulded base and cowl wired with switched lead complete with 40W silverlight lamp.	0.567	1.25
DRP 40W	Basic pack comprising white moulded base and cowl wired with switched lead complete with 40W silverlight lamp	0.567	1.25
DRB 40R	Red base only complete with 40W silverlight lamp	0.288	0.625
DRB 40W	White base only (lamp not included)	0.227	0.5
DRC 40R	Red cowl	0.113	0.25
DRC 40W	White cowl	0.113	0.25
DRS 40	Switched lead assembly	—	—

Modern adjustable pendants

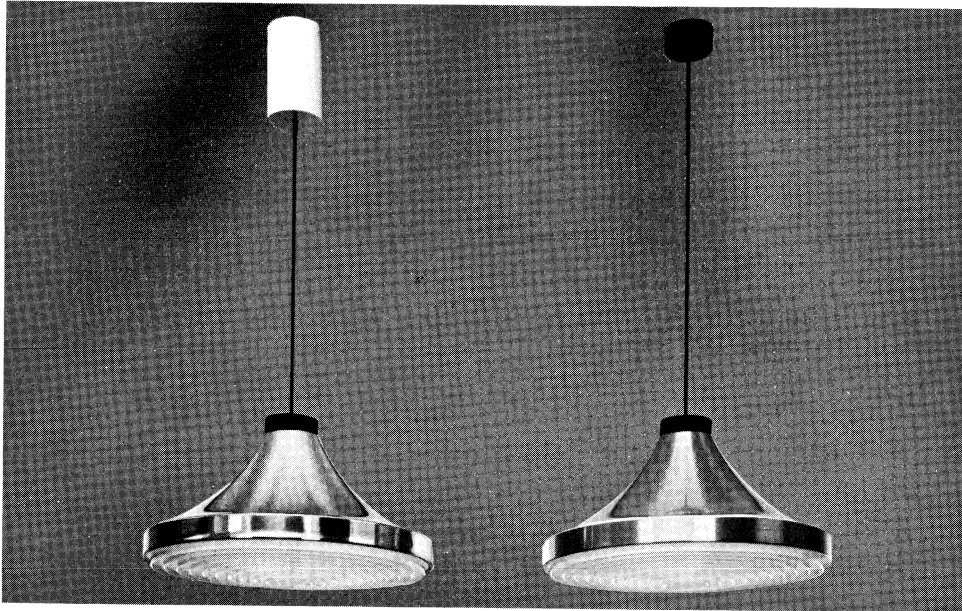

WZA Rise and fall, also cable suspension

Modern adjustable pendants

A superior quality adjustable pendant in three reflector finishes: spun copper polished and laquered; spun brass, polished and laquered; and spun aluminium, brushed and laquered. Complete with white plastic concentric louvre suspended on black cable from ceiling mounted rise and fall unit having white cover. Also available as fixed suspension on black cable from matching ceiling plate. Suitable for use with 100W lamp.

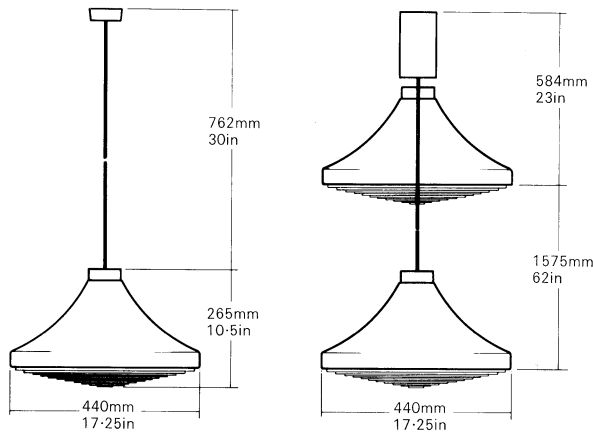

Range

Catalogue no.	Description
WZA 100C	Adjustable pendant with copper reflector and white louvre
WZA 100B	Adjustable pendant with brass reflector and white louvre
WZA 100S	Adjustable pendant with brushed silver reflector and white louvre
WZC 100C	Fixed suspension with copper reflector
WZC 100B	Fixed suspension with brass reflector
WZC 100S	Fixed suspension with brushed silver reflector

Modern adjustable pendants

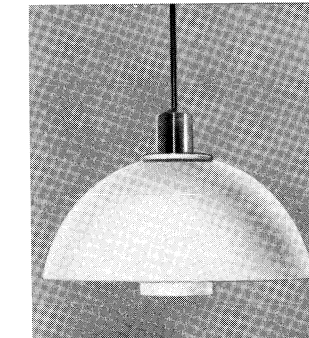

WAM 1100W

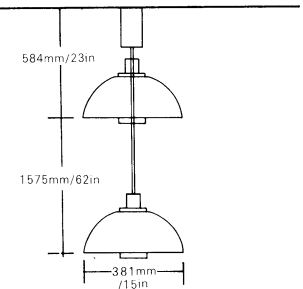

Catalogue no.	Colour	Lamp watts	Weight (ex. lamp)	
			kg	lb
WAM 1100S	Brushed silver	100	1.6	3.625
WAM 1100A	Amber	100	1.6	3.625
WAM 1100P	Purple	100	1.6	3.625
WAM 1100LB	Brushed and lacquered brass	100	1.6	3.625
WAM 1100W	White	100	1.6	3.625

Show-off range

Here, in handsome modern styling, is a range of fittings designed to give special light emphasis whenever and wherever it is wanted - on pictures, for example, or on treasured antiques, on precious pieces of porcelain or any corner where attention wants to be focussed. The range has been created with maximum versatility in mind. In fact, the Show-offs are available in three different styles. The first is a simple pendant spotlight (WN) which produces a controlled pool of light when used at low level, and is ideal for putting a fresh accent of light on coffee tables and bars. The second is an adjustable pendant (WV) which can easily be moved vertically and horizontally by using the two side knobs and the cable clamp. The third is another adjustable spotlight (vertical or horizontal) for wall or surface mounting. This type (WW) includes a pushbutton switch on the wall plate. All three types come complete with a 60W BC lamp and auxiliary reflector, and are available in an attractive colour choice of white, orange, or golden brown gloss stove enamel.

WV 1060R WN 1060BN WV 1060BN WN 1060R

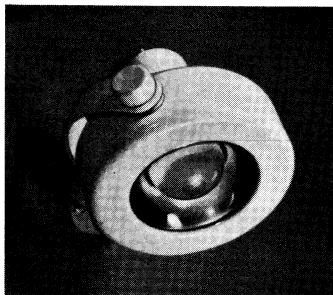

WW 1060W

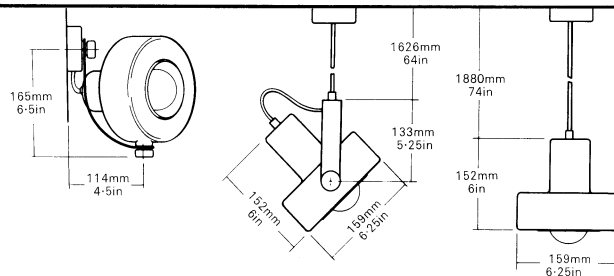

Catalogue no.	Colour	Type	Weight (incl. lamp)	
			kg	lb
WN 1060W	White	Pendant	0.45	1
WN 1060R	Orange	Pendant	0.45	1
WN 1060BN	Brown	Pendant	0.45	1
WV 1060W	White	Pendant (adj)	0.85	1.75
WV 1060R	Orange	Pendant (adj)	0.85	1.75
WV 1060BN	Brown	Pendant (adj)	0.85	1.75
WW 1060W	White	Wall-mounted	0.6	1.375
WW 1060R	Orange	Wall-mounted	0.6	1.375
WW 1060BN	Brown	Wall-mounted	0.6	1.375

Modern domestic spotlights

Top-spot

Two versions of Top-spot are readily available: VTC, a wall or ceiling mounted spot; and VTD, a desk lamp.

Both types are available in matt black or gloss white and fitted with chrome attachments and red adjustment knob and toggle switch (desk light only). A stainless steel lamp cover completes a very pleasing appearance and cuts out glare from the lamp filament.

	Colour	Catalogue no.
Desk-lamp	White	VTD 60W
Desk lamp	Black	VTD 60B
Ceiling fitting	White	VTC 60W
Ceiling fitting	Black	VTC 60B

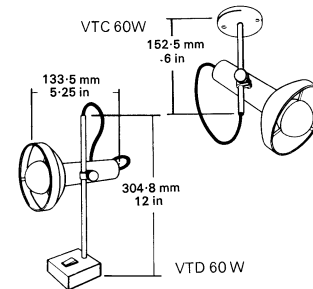

VTC 60W

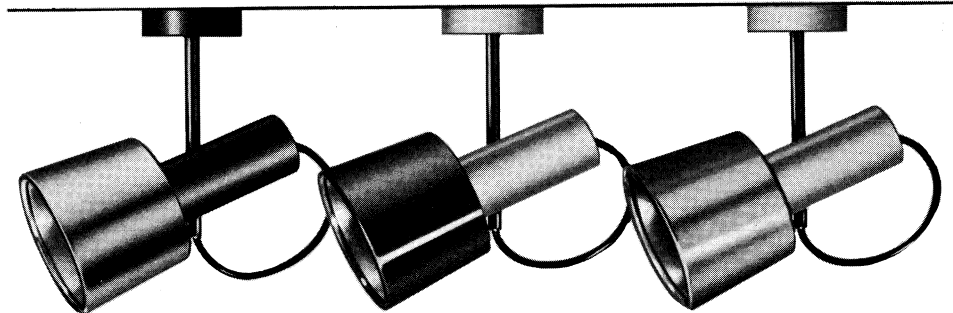

Domestic spotlight

This adjustable spotlight is designed for wall or ceiling mounting. It is available in four finishes and comes complete with 100W internally silvered spotlamp. An easily fitted push switch is available as an optional extra.

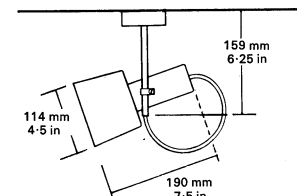

Catalogue no.	Reflector	Back spinning	Back plate	Weight	
				kg	lb
WS 1100	Brushed and lacquered silver	Black	Black	0.22	0.5
WS 1100SW	Brushed and lacquered silver	White	White	0.22	0.5
WS 1100CW	Brushed and lacquered copper	White	White	0.22	0.5
WS 1100W	White	White	White	0.22	0.5
WS 4600	Pushbutton switch kit				

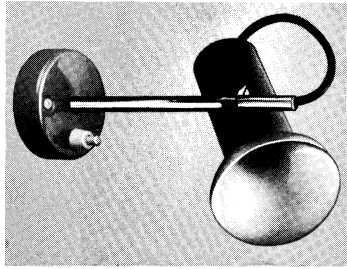

WIS 60R

Modern domestic spotlight

An extensive range of spotlight fittings using the new 60W Decor spotlamp and fully adjustable. Also suitable for use with 75W and 100W reflector lamps.

Wall mounted

Spotlight incorporating push switch in wall plate wired with terminal block. Available in four finishes, painted brown, orange and white or natural anodized aluminium.

Floor standard

Standard with two spotlights and foot operated floor switch matching unit to Pin-up and Pan floor stands.

Spotlights in painted finishes, orange and white, on chromium plate stem with contrasting black weighted base.

Table stand

Stand with one spotlight mounted on chromium plated stem on contrasting black weighted base incorporating rocker switch. Spotlight in two painted finishes, orange or white.

Trak-pack

Two white painted spotlights mounted on 1.2m/48in length of system (TKN 1200)

Ceiling unit

Three way ceiling mounting unit with three spotlights in white mounted on chromium plated tubes from white ceiling plate.

All fittings packed complete with 60W Decor spot lamps.

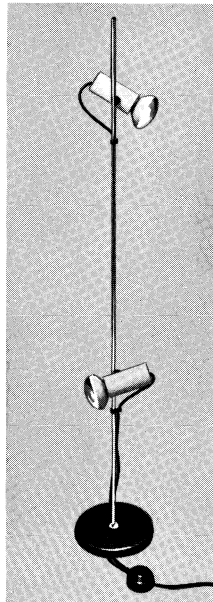

WIF 60R

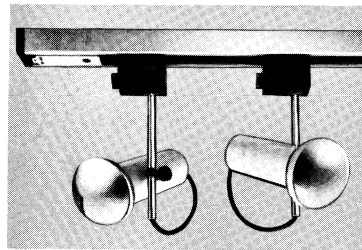

WIP 60W

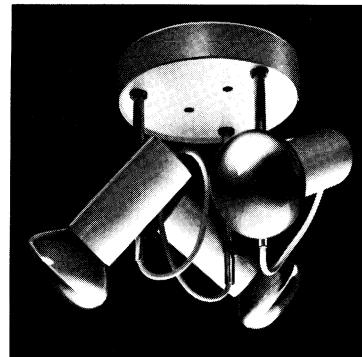

WIT 60R

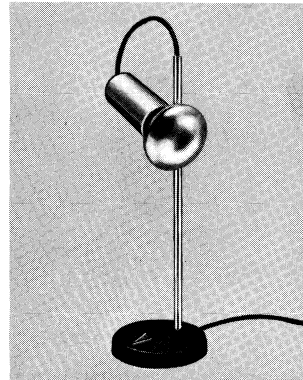
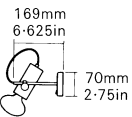
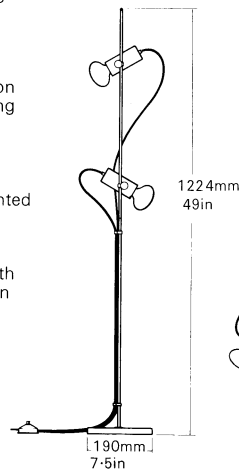

WIT 60W

Range

Catalogue no.	Description
WIS 60A	Wall mounted spotlight—anodized
WIS 60BN	Wall mounted spotlight—brown
WIS 60R	Wall mounted spotlight—orange
WIS 60W	Wall mounted spotlight—white
WIF 60R	Floor standard with two orange spotlights
WIF 60W	Floor standard with two white spotlights
WIT 60R	Table stand with one orange spotlight
WIT 60W	Table stand with one white spotlight
WIP 60W	Trak-pack with two white spotlights
WIC 60W	Three way ceiling mounting with three white spotlights



VK 40W

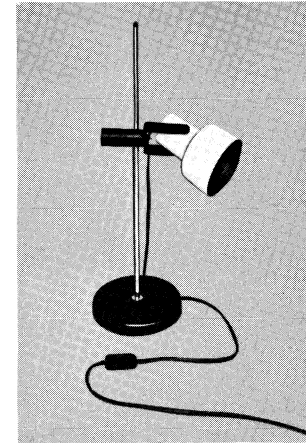

VKT 40W

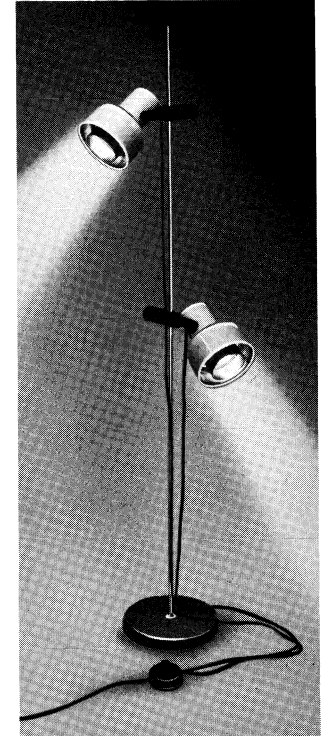

VKF 40R

Pin-up

A lightweight moulded plastic housing encloses a polished metal reflector and a black plastic spill ring. It is mounted on a black plastic gimbal swivelling on a plastic base. Reflectors are fully adjustable by unique friction device. The range comprises a wall mounted spotlight, a floor standard and a table lamp, supplied complete with 40W 45mm round SES lamp.

Wall mounted

Housing and back plate in matching colours, brown, orange or white. Wired complete with 3m/9.8ft of white twin cable and torpedo switch.

Floor standard

Two reflectors in matching colours—orange or white—are mounted on a two part chromium stem for convenience of packing and storage. Contrasting black weighted base wired with black flex to a foot operated floor switch controlling individual or both reflectors.

Table stand

A matching unit to the floor standard having single reflector in matching colours and wired with torpedo switch.

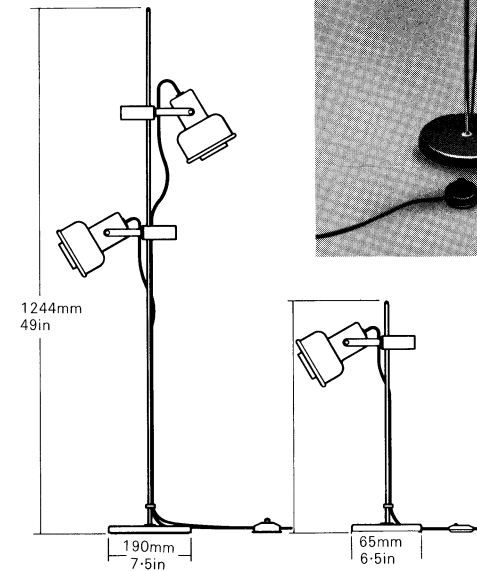

Range

Catalogue no.	Description
VK 40BN	Wall mounted spotlight—brown
VK 40R	Wall mounted spotlight—orange
VK 40W	Wall mounted spotlight—white
VKF 40R	Floor standard with two orange reflectors
VKF 40W	Floor standard with two white reflectors
VKT 40R	Table stand with single orange reflector
VKT 40W	Table stand with single white reflector

Pan floor and table stand

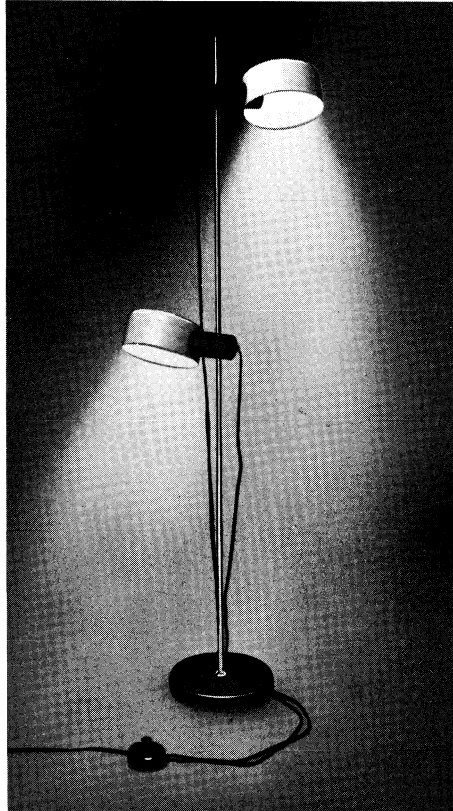

VNF 60RD

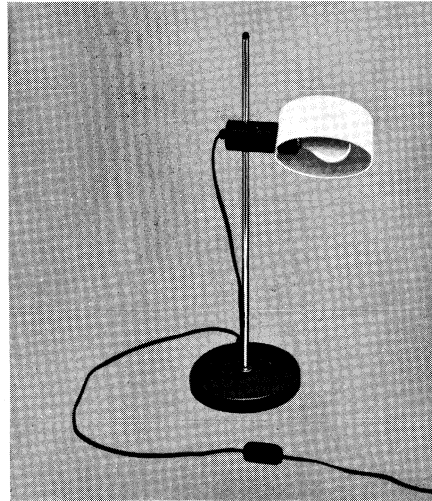

VNT 60W

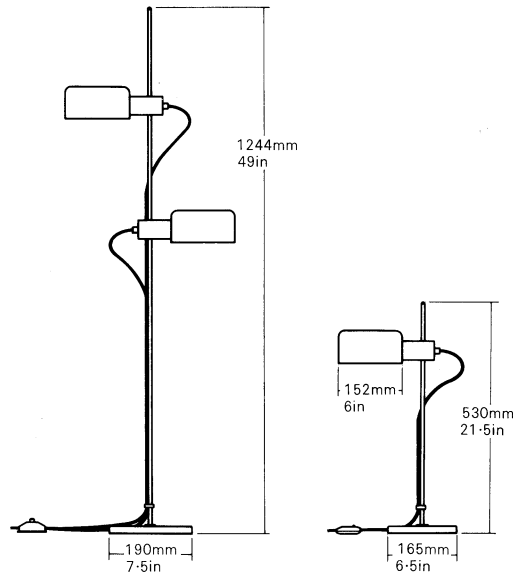

Pan floor and table stand

The floor and table stands of this range are the same as those of the Pin-up range. The aluminium reflector is "pan" shape in red or white. The same friction device is used for reflector adjustment with the same switching arrangement. Packed complete with two 60W pearl lamps.

Range

Catalogue no.	Description
VNF 60RD	Floor standard with two red reflectors
VNF 60W	Floor standard with two white reflectors
VNT 60RD	Table stand with single red reflector
VNT 60W	Table stand with single white reflector

Occasional and ceramic based lamps

Occasional lamp

The orange or white flashed opal glass completely encloses a BC lampholder. The fitting is packed complete with a white flexible torpedo switch and a 60W lamp.

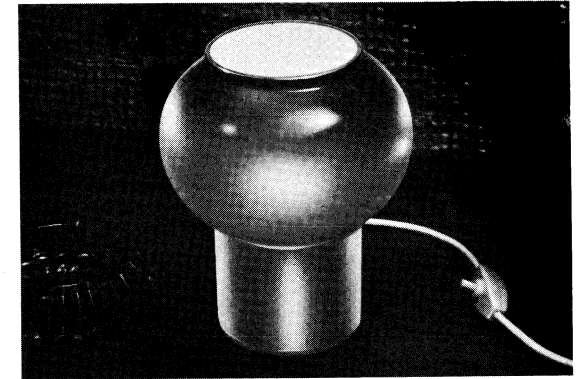
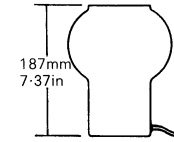

Range

Catalogue no.	Colour
WO 1060R	Orange opal
WO 1060W	White opal

Ceramic based lamp

The orange or white flashed opal glass completely encloses the lamp and is mounted on a white ceramic base. This fitting is packed complete with a white flexible torpedo switch and a 60W lamp.

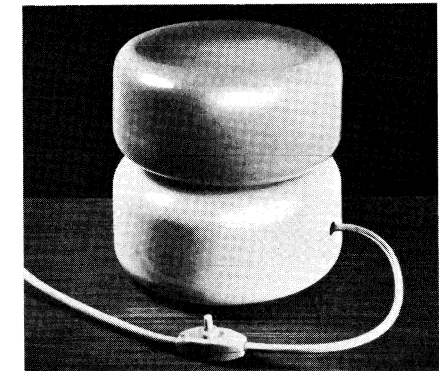
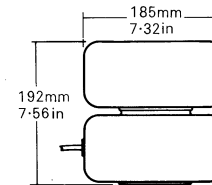

Catalogue no.	Colour
WG 1060W	White opal
WG 1060R	Orange

Yo-Yo lamp

A two part glass table lamp in white flashed opal with alternative base in orange colour glass. Wired complete with ample length of white cable and torpedo switch. Packed with 60W pearl lamp.

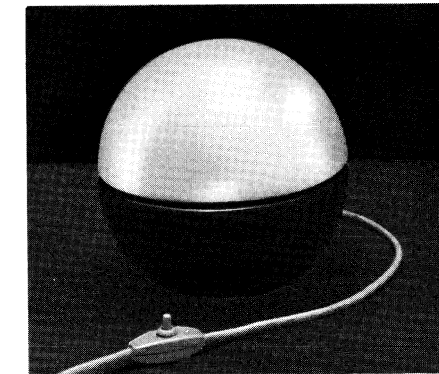
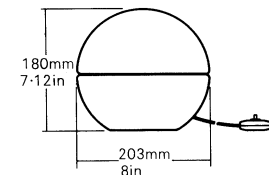

Catalogue no.	Colour
WY 1060R	White top, orange base
WY 1060W	All white

Modern domestic cylinders and Novelle

WH 100 A high quality surface mounted cylinder in a brushed silver finish with low brightness baffles to eliminate glare. Provides the basic functional lighting to modern standards with visual comfort, the very solution to many lighting problems. Packed complete with 100W GLS lamp with clip-on auxiliary reflector.

If the fitting is required to be recessed into the ceiling a redesigned bezel WR 100 can be used. This bezel is fitted with spring clips which hold the cylinder firmly yet permit projection to be adjusted with no effort. The WR 100 can be fitted from below using simple "quick fix" clips.

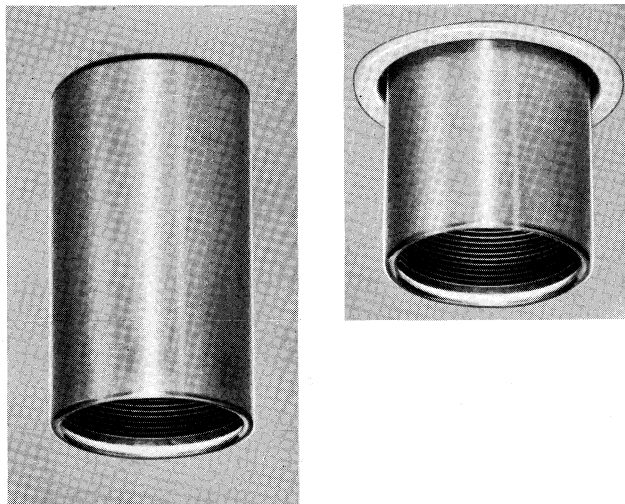

	Catalogue no.	Weight kg	Weight lb
Ceiling cylinder	WH 100	0.57	1.25
Adjustable bezel ring	WR 100	0.11	0.25

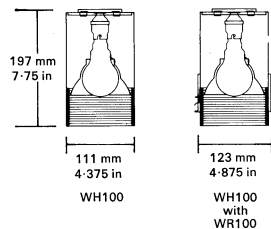

The Novelle fitting consists of a very shallow satin opal glass (NL 100 and NL 200) and gallery to which has been added a decorative gold fabric trim. It is designed to take one or two 100W lamps. The glass shade and gallery are for direct ceiling mounting by means of screws on standard 51mm/2in centres.

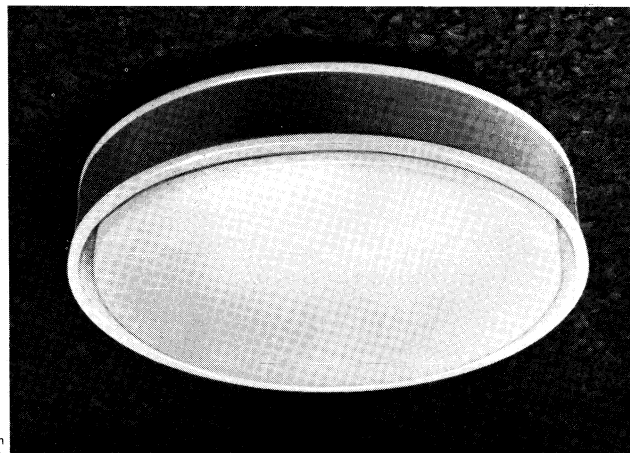

Catalogue no.	Colour	Lamp watts
NLH 100G	Gold	100
NLH 200G	Gold	2 x 100

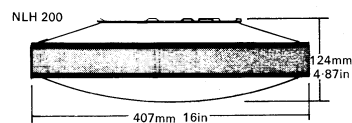
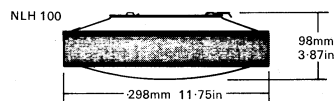

Catalogue no.	Colour	Lamp watts	Glassware	Gallery	Trim
NLH 100G	Gold	100	NFG 100	NCB 100	NLHT 100G
NLH 200G	Gold	2 x 100	NFG 200	NLB 200	NLHT 200G

Au Pair and One-Up fittings

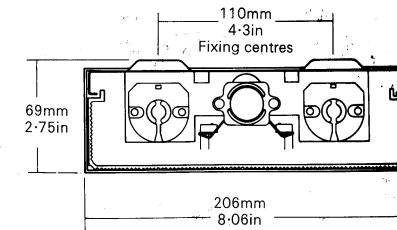
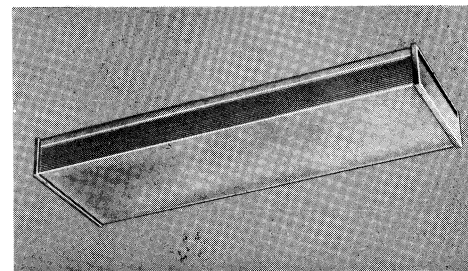

The shallow construction of the Au Pair Homelight is designed to meet the requirements of kitchens and similar locations but it has many other uses in the home. The enclosed structure excludes dust and flies and the prismatic controller reduces glare.

The body of the fitting is made of sheet steel, stove enamelled white. Suitable for Class 1 ordinary, indoor, normal atmospheres. Registered design no. 943062.

RANGE: Packed complete with Warm White tubes

Complete fitting										
Nominal length	Rating	Circuit	Catalogue no.	Length mm	Length in	Weight kg	Weight lb	Fixing centres		
600mm/2ft	20W Twin	Switchstart	SK 220	630	24.8	2.76	6.25	400	15.75	

Voltages: These fittings are suitable for 230/240V 50Hz. Details of fittings suitable for other supplies are available on application. End plate (Catalogue no. SK 4600) and prismatic controller (Catalogue no. SK 4610) are available as replacement items.

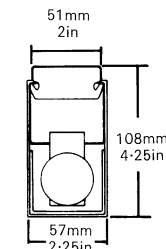
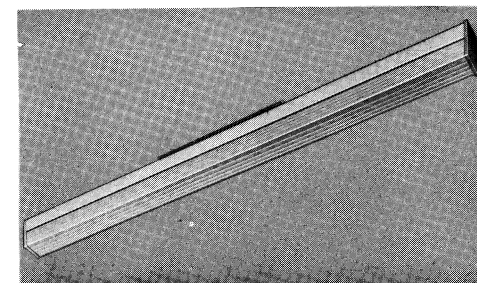

The One-Up diffuser fitting is constructed of sheet steel, stove enamelled white, with a white opal plastic diffuser. The white plastic end plates have a trim of metallic appearance. The fitting is extremely easily installed by means of a bracket

which is first fixed to the ceiling and on to which the complete fitting is latched. It gives some 7% more light than a more conventional fitting. Suitable for Class 1, ordinary, indoor, normal atmospheres.

Supply voltage
Standard fitting 230/240V 50Hz. Details of fittings for other supplies are available on application.

RANGE: Packed complete with 40W Warm White tube

Complete fitting										
Size	Circuit	Catalogue no.	Length mm	Length in	Weight kg	Weight lb	Fixing centres			
1200mm/4ft Single	Switchstart	1 UP	1193	48.4	2.55	5.6	280	11		

End plate (Catalogue no. UP 4600) and prismatic controller (Catalogue no. UP 4601) are available as replacement items.

Viewpoint combined light and shaver point

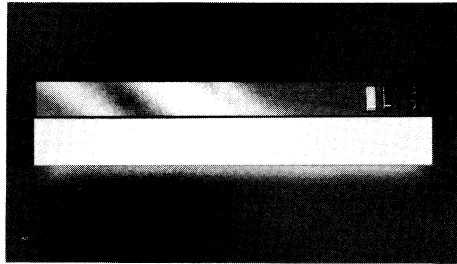

LS 15

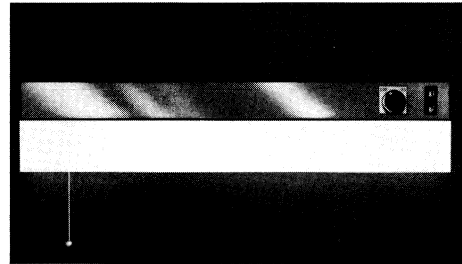

LST 15

These fluorescent fittings are designed for use in hotels, hostels and homes. There is one model for bedroom and general purpose use and another for use in the bathroom. The fittings employ the 15W 450mm/18in (26mm/1in dia.) Warm White tube, the most efficient tube in the shorter sizes. Both models have a body of slate grey plastic fixed to a substantial steel backplate. The front panel has a trim with a brushed silver appearance.

The LS 15 is the general purpose type incorporating a shuttered mains voltage shaver socket and is suitable for use in all rooms *excluding the bathroom*.

The LST 15 is the bathroom model and this has a dual voltage output (115/230V) from the shaver socket from a double wound transformer to BS.3052 and a pull-switch. This fitting complies with IEE Regulations for bathroom equipment.

Supply voltage
Supply fitting 230/240V 50Hz.
Details of fittings for other supplies are available on application.

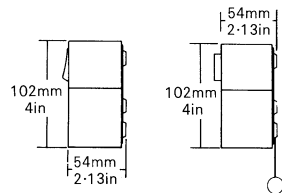

RANGE: Packed complete with 15W Warm White tube
Complete fitting

	Circuit	Catalogue no.	Length		Weight		Fixing centres	
			mm	in	kg	lb	mm	in
General purpose (bedroom) type	Switchstart	LS 15	470	18.5	2	4.5	279	11
Bathroom type	Quickstart	LST 15	470	18.5	3.23	7.13	279	11

Diffuser (Catalogue no. LS 4600) is available as a replacement item

Netaline and Litepak

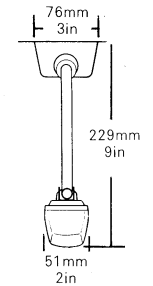
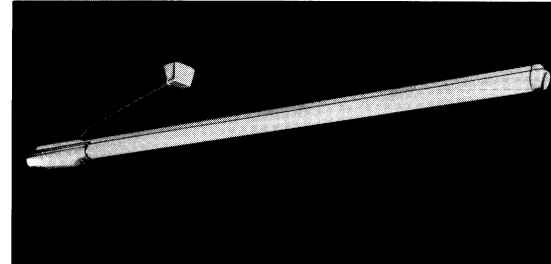

The Netaline fitting is designed for easy installation on an existing ceiling point. It is of sheet steel finished in white gloss enamel, except for the plated support arm, and is packed complete with tube and instruction leaflet. Suitable for Class 1, ordinary, indoor, normal atmospheres.

RANGE: Packed complete with Warm White tube

Size	Circuit	Catalogue no.	Length		Weight	
			mm	in	kg	lb
1200mm/4ft Single	Switchstart	4 NLI.W	144	56.75	1.13	2.5

standard voltage 230/240V 50HZ

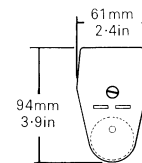

The 1200mm/4ft Litepak is a slim-sectioned, single lamp fluorescent fitting, manufactured from top quality steel, with a full bonderising and rust inhibiting process before application of white stoved enamel. Plastic moulded light blue end pieces form a one piece end to the channel. These ends are each secured by means of a single recessed screw and are spring-

loaded to facilitate re-lamping and channel cover fixing. In addition, the moulding of the end piece is extended to act as a lampholder shroud and provide a re-lamp guide. The Litepak is assembled complete with control gear, channel cover, Warm White tube and full instruction leaflet, all packed in a strong attractive carton. Suitable for Class 1, ordinary, indoor, normal atmospheres.

Supply voltage
Standard fitting 230/240V 50Hz
Details of fittings for other supplies are available on application.

RANGE: Packed complete with Warm White tube
Complete fitting

Rating	Circuit	Catalogue no.	Length		Weight		Fixing centres	
			mm	in	kg	lb	mm	in
40W Single	Switchstart	4 MLB.1	1224	49	2.5	5.5	612	24

'Circline' fluorescent fittings

The range of 'Circline' fittings has been designed for use in both domestic and commercial applications.

A triangular shaped gear tray containing 60W switchstart control gear is completely hidden from view by the wide range of attractive diffusers. These fittings blend with all decors and colour schemes.

The fitting shown on this page is for ordinary, indoor normal atmospheres.

CF/OW.60/0

The new Circline fitting has an orange woven Raffia style shade attachment with an opal polystyrene dish diffuser which completely conceals the fluorescent tube. The attachment is easily removed by means of spring clips which locate over the fluorescent tube.

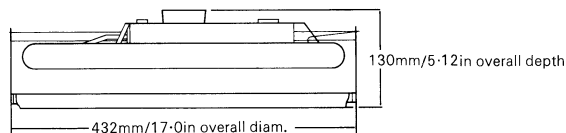
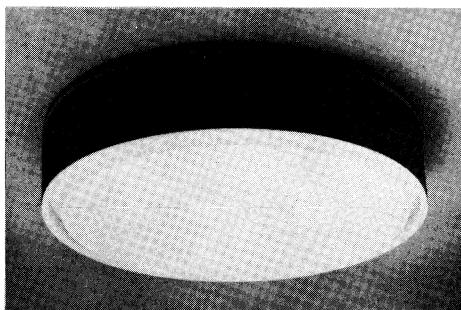

RANGE: Packed complete with Warm White tube

Rating	Circuit	Catalogue no.	Description
60W Single	Switchstart	CF/OW.60/0	Orange weave fitting

Voltages: These fittings are suitable for 230/240V 50Hz.
Details of fittings suitable for other supplies are available on application.

Opal diffuser dish
(Catalogue no. CF 4603) is available as a replacement item.

Circline fluorescent fittings

The fittings shown on this page are for ordinary, indoor, normal atmospheres.

CF/LSG60 Large Sparkle Glass diffuser fitting

This bowl diffuser is moulded in clear glass with a smooth upper surface for easy cleaning and a random embossed, patterned lower surface which sparkles even when the fitting is unlit. A radial pattern is silk screened in white on the upper surface of the glass which is attached to the fitting by a white plastic knob with an aluminium insert. The glass completely obscures the fluorescent tube from view.

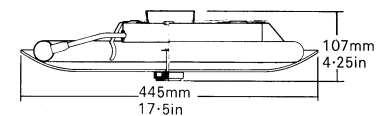
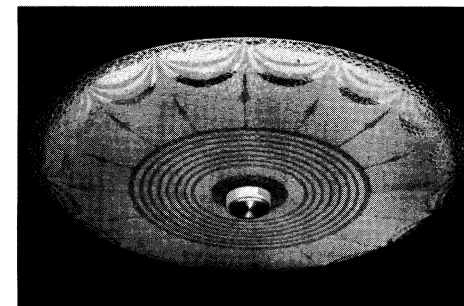

CF/SPG60 Sparkle Glass fitting

The diffuser is moulded in clear glass with a smooth upper surface for easy cleaning. A pattern is silk screened in white on the upper surface of the glass which is held to the fitting by a white plastic knob with aluminium insert which holds the glass flush to the tube.

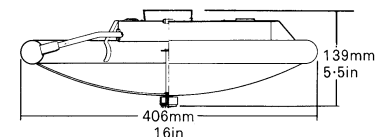
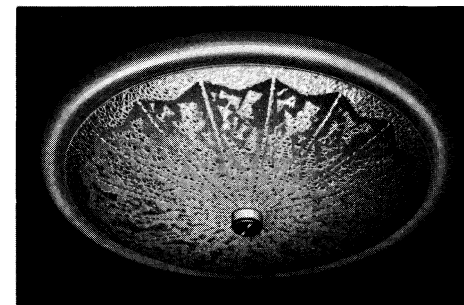

Supply voltage

Standard fitting 230/240V Hz.
Details of fittings for other supplies are available on application.

RANGE: Packed complete with Warm White tube

Rating	Circuit	Catalogue no.	Description
60W Single	Switchstart	CF/LSG-60	Large Sparkle Glass fitting
60W Single	Switchstart	CF/SPG-60	Small Sparkle Glass fitting

Large sparkle glass retaining knob (Catalogue no. CF 4607) and sparkle glass retaining knob (Catalogue no. CF 4608) are available as replacement items.

'Circline' fluorescent fittings

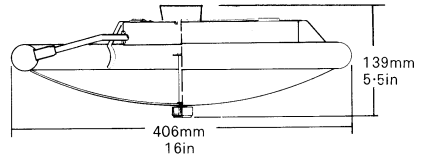
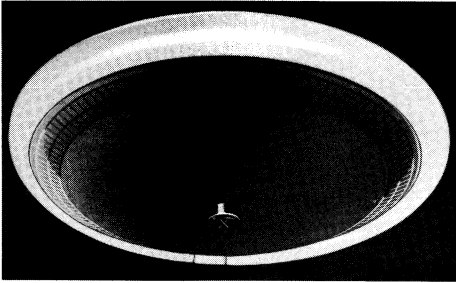

The fittings shown on this page are for ordinary, indoor, normal atmospheres.

CF/WHG.60 White Glass fitting

This fitting with its diffuser moulded in smooth glass for ease of cleaning is suitable where a relatively plain diffuser bowl is required. The diffuser bowl is held flush to the fluorescent tube by a white knob with an aluminium insert.

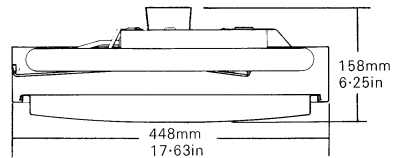
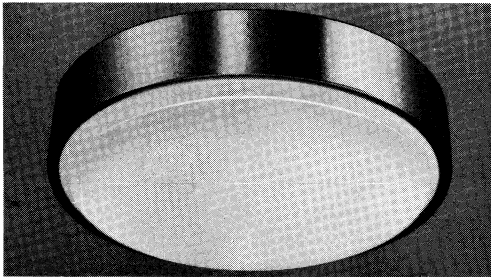

CFA 60 Fitting

The anodized aluminium attachment is simply assembled by locating over the centre screw on the gear tray and securing in position. A white opal dish is then inserted.

This fitting is packed in one carton complete with gear tray, aluminium attachment and tube.

RANGE: Packed complete with Warm White tube

Rating	Circuit	Catalogue no.	Description
60W Single	Switchstart	CF/WHG.60	White glass fitting
60W Single	Switchstart	CFA.60	Aluminium frame fitting

Voltagess : These fittings are suitable for 230/240V 50Hz.
Details of fittings suitable for other supplies are available on application.

Aluminium frame (Catalogue no. CF 4601), opal diffuser dish (Catalogue no. CF 4603) are available as replacement items.